

MADE IN ITALY. MADE TO EXCEL.

AIX



atlas concorde

September 2019



Index

Overview



Spaces

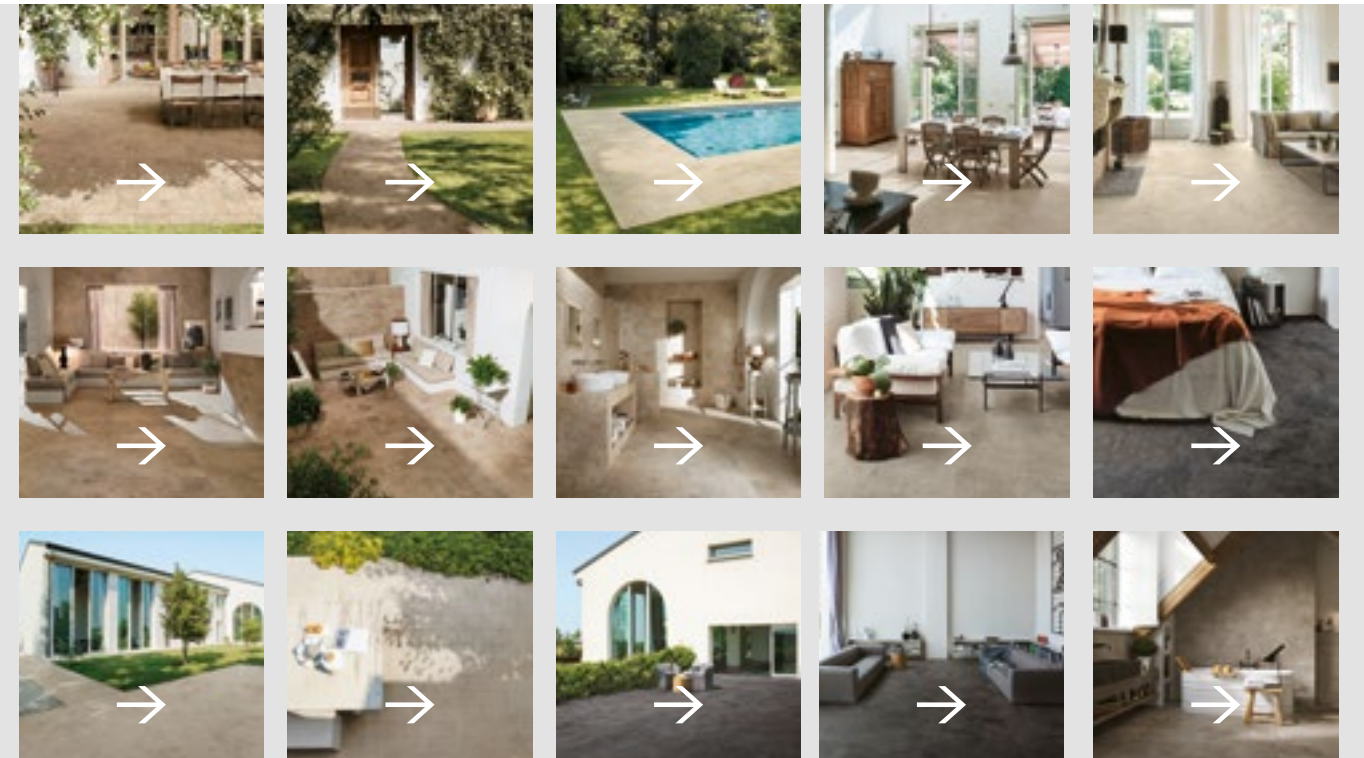

Product Range

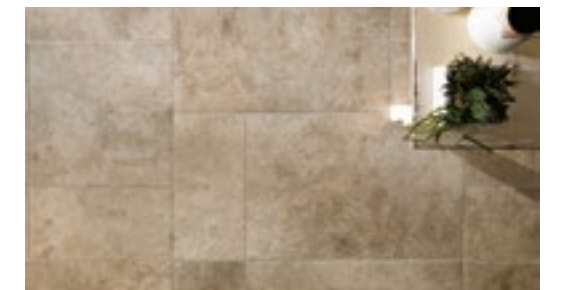

Technical Specifications



STONE LOOK
AIX
Porcelain and wall tiles

Ceramic and porcelain tiles: a safe choice

● IT DOES NOT BURN
Non brucia

● RECYCLABLE
Riciclabile

● HYGIENIC
Igienico

● VERSATILE
Versatile

● IT LOVES THE ENVIRONMENT
Ama l'ambiente

● LONG LASTING
Dura a lungo

● SAFE
Sicuro

● RESISTANT
Resistente

● ZERO PVC
Zero PVC

● ZERO VOCS
Zero VOC



A story that continues to inspire emotions

Une collection contemporaine qui rappelle les sols originaux d'une villa française du XVIII^e siècle. Telle est l'inspiration de Aix, formée d'anciennes pierres calcaires utilisées comme matrice et récupérées une à une en dalles de différents formats. Les pierres, qui offrent des variations de graphisme et de couleur, représentent le modèle qui reproduit une surface en pierre irrégulière et non homogène, ornée de taches et nuances qui exaltent le charme des traces laissées par le temps.

Eine zeitgenössische Kollektion, die an den alten Bodenbelag einer französischen Villa aus dem 18. Jahrhundert erinnert. Die Inspiration durch AIX aus altem Kalkstein, der als Grundmaterial verwendet und in Platten verschiedener Größe wieder verwertet wird. Die Steine bilden mit ihren unterschiedlichen Grafiken und Farben das Grundmuster einer unregelmäßig und uneben reproduzierten, mit Flecken und Schatten durchzogenen Steinoberfläche, welche die Spuren der Zeit hervorheben.

Una colección actual que trae a la memoria el suelo original de una villa francesa del siglo XVIII. Aix se inspira en las piedras calizas empleadas como modelo y recuperadas una a una en placas de distintos tamaños. Las piedras de diferentes colores y diseños conforman un patrón que reproduce una superficie de piedra irregular y dispar, cubierta de manchas y matices que destacan el encanto de las huellas del paso del tiempo.

Современная коллекция, вдохновленная оригинальным полом французской виллы восемнадцатого века. Это и есть Aix, в состав которой входят плиты различных форматов, изготовленные поштучно на основе старинного известняка. Разнообразные рисунки и цветовые оттенки природного камня явились моделью, воспроизведенной на поверхности плит, неровной и разнородной, испещренной пятнами и другими отметинами времени, придающими им несравненное очарование старины.



A contemporary collection that recalls the original flooring of an 18th century French villa. This is the inspiration behind Aix, formed of ancient calcareous stones used as a matrix and recovered one by one in sheets of various size. The stones, which vary in pattern and color, are the model that reproduces an irregular and patchy stone surface, complete with markings and shading that enhances the appeal of footprints in time.

Una collezione contemporanea che richiama alla memoria la pavimentazione originale di una villa francese del Settecento. Questa l'ispirazione di Aix, formata da antiche pietre calcaree utilizzate come matrice e recuperate una ad una in lastre di varia pezzatura. Le pietre, variegata nelle grafiche e nelle cromie, sono il modello che riproduce una superficie lapidea irregolare e disomogenea, percorsa da macchie e sfumature che ne esaltano il fascino delle tracce del tempo.



A style with two souls



Clearly referencing the European design culture for stone, the perfect symbiosis between architecture and nature, Aix comes in a range of colors to fit different contexts: warm colors linked to the Mediterranean architectonic culture of villas, French mas, and residences immersed in the southern countryside; colder tones for the Middle-European feel of ancient dwellings across French, Belgium, Germany or Great Britain.

Con un forte richiamo alla cultura progettuale europea in pietra, simbiosi perfetta tra architettura e natura, Aix è declinata in una gamma cromatica in sintonia con i contesti delle diverse latitudini: colori caldi legati alla tradizione architettonica mediterranea di ville, mas provenzali e residenze immerse nella natura del Sud; tonalità più fredde che evocano atmosfere della Mitteleuropa e antiche dimore collocate dalla Francia al Belgio, dalla Germania alla Gran Bretagna.

S'inspirant de la culture conceptuelle européenne de la pierre, symbiose parfaite entre architecture et nature, Aix se décline autour d'une gamme chromatique en harmonie avec les ambiances des différentes régions : couleurs chaudes et sudistes de la tradition architecturale méditerranéenne des villas, mas provençaux et résidences en pleine nature, tonalités plus froides évoquant les atmosphères de l'Europe centrale et les anciennes demeures de France et de Belgique, d'Allemagne et de Grande-Bretagne.

Mit einem starken Bezug zur europäischen Designkultur aus Stein, einer perfekten Symbiose zwischen Architektur und Natur, wird Aix in einem chromatischen Bereich in Harmonie den Kontexten der verschiedenen Breitengrade angepasst: Warme Farben, die mit der mediterranen Bautradition von Villen, provenzalischen Bauernhöfen und Residenzen in der Natur des Südens verbunden sind; sowie kühlere Farbtöne, die an mitteleuropäische Atmosphären und alte Wohnhäuser von Frankreich bis Belgien, von Deutschland bis Großbritannien erinnern.

Con una enérgica referencia a la cultura europea del diseño en piedra, simbiosis perfecta entre arquitectura y naturaleza, Aix está disponible en una gama de colores en sintonía con los entornos de las diferentes latitudes: colores cálidos vinculados a la tradición arquitectónica mediterránea de las villas, las masías provenzales y las residencias inmersas en la naturaleza meridional, y tonos más fríos que recuerdan la atmósfera de la «Mitteleuropa» y las casas antiguas que salpican la geografía desde Francia hasta Bélgica, desde Alemania hasta Gran Bretaña.

Отдавая должное европейской культуре строительства каменных зданий с ее замечательным симбиозом архитектуры и природы, создатели коллекции Aix выполнили ее в различных хроматических вариантах, соответствующих разным широтам: в теплых цветах, присущих средиземноморской архитектурной традиции, характерной для вилл, провансальских масов и утопающих в богатой южной зелени резиденций; в более холодных цветах, вызывающих в памяти атмосферу Центральной Европы и старинные особняки, разбросанные на пространстве от Франции до Бельгии, от Германии до Великобритании.



BLANC



CENDRE



BEIGE



FUMÉE

Continuity, inside and out



The seasoned appearance of Aix reinforces the link between the living space and the surrounding nature, for stylistic and functional continuity between the indoor and outdoor. A growing trend in architecture, and one that creates a spatial continuity that increases the perceived space of the interior towards the exterior. The wide range of outdoor sizes and different thicknesses allow for the identification of solutions that fit perfectly with landscape design needs.



L'aspetto vissuto di Aix rafforza il legame tra lo spazio abitativo e la natura circostante, in continuità stilistica e funzionale tra indoor e outdoor. Una tendenza che va sempre più affermandosi in architettura, capace di creare una continuità spaziale che moltiplica lo spazio percettivo degli interni verso l'esterno. La ricchezza dei formati per l'outdoor e i diversi spessori permettono di trovare soluzioni in perfetto equilibrio con le esigenze di landscape design.

L'aspect vécu de Aix renforce le lien entre l'espace de vie et la nature alentour, créant une continuité stylistique et fonctionnelle entre intérieur et extérieur. Une tendance qui s'affirme de plus en plus dans l'architecture, offrant une continuité spatiale qui démultiplie l'espace perçu des intérieurs vers l'extérieur. La richesse des formats pour l'extérieur et les différentes épaisseurs permettent de trouver des solutions en parfait équilibre avec les exigences d'aménagement.

Die Spuren der Vergangenheit von Aix verstärken die Verbindung zwischen Wohnumgebung und Natur, in stilistischer und funktionaler Kontinuität zwischen innen und außen. Ein Trend, der sich in der Architektur immer mehr durchsetzt und eine räumliche Kontinuität schafft, die die Wahrnehmung des Innenraums nach außen vervielfacht. Die Vielfalt der Formate für den Außenbereich und die unterschiedlichen Stärken ermöglichen es, Lösungen zu finden, die perfekt auf die Bedürfnisse der Landschaftsgestaltung abgestimmt sind.

El aspecto vivido de Aix refuerza el vínculo entre el espacio habitable y la naturaleza circundante en un continuo estilístico y funcional entre interior y exterior. Una tendencia que está en auge en la arquitectura y que permite crear una continuidad espacial que multiplica la percepción del espacio desde dentro hacia fuera. La profusión de formatos para exterior y los diferentes espesores permiten encontrar soluciones en perfecto equilibrio con las exigencias del paisajismo.

Эффект старины, присущий коллекции Aix, усиливает связь между жилым пространством и окружающей природой, создавая между ними неразрывное функциональное и стилистическое единство. Это соответствует все более четко проявляющейся архитектурной тенденции, которая направлена на создание пространственного единства, позволяющего визуально увеличивать объем интерьеров за счет как бы продолжающих их наружных пространств. Широкий выбор форматов плит для наружных пространств и их различная толщина позволяют находить решения, в идеальной степени удовлетворяющие требованиям ландшафтного дизайна.



PATIO ¹⁴

WALKWAY ²⁰

POOL ²²

IN&OUT ²⁴

LIVING ²⁸

RECEPTION ³²

OUTDOOR CORNER ⁴⁴

BATHROOM ⁵⁴

LIVING ⁶²

BEDROOM ⁶⁸

DINETTE ⁷²

GATEWAY ⁷⁴

YARD ⁸⁰

COURT ⁸⁴

LIVING ⁸⁶

BATHROOM ⁸⁸

Ideal for the restructuring of residential and high-end hospitality spaces such as country homes and manor houses, farmhouses, masserie, period buildings, and luxury country hotels, Aix is perfect for those architectonic projects that associate contemporary style with natural accents, with cladding that is reminiscent of stone, worn over time, in soft, blended shades.

Perfetta per ristrutturazioni di spazi residenziali e hospitality di alta gamma quali dimore e ville padronali, case coloniche, masserie, edifici d'epoca, hotel de charme, Aix è ideale per progetti architettonici che associano allo stile contemporaneo accenti naturali con un rivestimento che rievoca una pietra consumata dal tempo, dalle tonalità morbide e sfumate.

Parfaite pour les restaurations d'espaces résidentiels et les établissements d'accueil haut de gamme, tels que demeures et villas seigneuriales, maisons rurales, mas, édifices d'époque, hôtels de charme, Aix est idéale pour les projets architecturaux associant style contemporain et accents naturels, avec un revêtement qui évoque une pierre usée par le temps, aux tons doux et nuancés.

Perfekt für die Renovierung von hochwertigen Wohn- und Gaststättenräumen, Villen und herrschaftliche Gebäude, Bauernhäuser, Bauernhöfe, historische Gebäude, Hotels de Charme, ist Aix ideal für Architekturprojekte, die den zeitgenössischen Stil mit natürlichen Akzenten und einem Oberbelag in Steinoptik mit weichen und nuancierten Tönen kombinieren, der die Spuren der Zeit trägt.

Perfecta para renovar zonas residenciales y hoteles de alto nivel, como mansiones y casas señoriales, casas coloniales, masías, edificios históricos y hoteles con encanto, Aix también resulta ideal para proyectos arquitectónicos de estilo moderno en tonos naturales con revestimiento semejante a la piedra gastada por el tiempo en tonos suaves y matizados.

Отлично подходящая для использования при реконструкции жилых и используемых для приема гостей помещений высшего сегмента, таких как бывшие виллы и особняки знати, колониальные дома, сельские усадьбы, исторические здания, престижные отели... коллекция Aix является идеальным решением для архитектурных проектов, которые сочетают современный стиль с натуральными облицовочными материалами, позволяя выполнять облицовку из плит с эффектом камня под старину с мягкими и размытыми хроматическими тонами.



COUNTRY FARMHOUSE

MEDITERRANEAN RESORT

ANCIENT VILLA

MANOR HOUSE

September 2019

Bright Atmospheres

COUNTRY FARMHOUSE

A villa with rustic appeal is the setting in which Aix reflects its sunniest and most Mediterranean side, recalling a stone worn over time, in the Blanc and Beige colors. The multi-size solutions in the collection create a tailor-made look, in harmony with the spirit of the place.

Una villa dal fascino agreste diventa lo scenario in cui Aix riflette la sua anima più solare e mediterranea, che rievoca una pietra consumata dal tempo, nei colori Blanc e Beige. Le soluzioni multiformato della collezione creano un look tailor made in armonia con lo spirito del luogo.

Une villa au charme rural devient le cadre où Aix reflète son esprit le plus solaire et méditerranéen, évoquant une pierre usée par le temps, dans les couleurs Blanc et Beige. Les solutions multiformat de la collection créent un look sur mesure pour l'esprit du lieu.

Eine Villa mit ländlichem Charme wird zum Schauplatz, in dem Aix seine sonnige und mediterrane Seele widerspiegelt und an einen Stein erinnert, der, in den Farben Blanc und Beige, die Zeichen der Zeit trägt. Die multiformatigen Lösungen der Kollektion schaffen einen maßgeschneiderten Look in Harmonie mit dem Geist des Ortes.

Una villa con encanto rústico es el escenario en el que Aix saca a relucir su lado más solar y mediterráneo, que evoca la piedra gastada por el tiempo, en colores Blanc y Beige. Las soluciones multiformato de la colección crean un «look» a medida en armonía con el espíritu del lugar.

Вилла с очаровательным сельским колоритом становится сценой, позволяющей коллекции Aix выразить наиболее светлую и средиземноморскую составляющую своей души. Это достигается с помощью образа изъеденного временем камня, который вызывают в воображении плиты, выполненные в цветах Blanc и Beige. Разноформатные решения коллекции создают индивидуальный облик, идеально гармонирующий с духом места.



atlas concorde



INDEX

OVERVIEW

SPACES

RANGE

TECH. SPECS



On the patio, the warm tones of the Beige color reflect light into the surrounding space, for a relaxing and welcoming environment that invites conviviality. The outdoor range, in 22.5x22.5 cm (8⁷/₈"x8⁷/₈"") and 22.5x45.3 cm sizes (8⁷/₈"x17³/₄""), is of particular interest thanks to its natural appearance.

Nel patio assolato, le calde tonalità della variante di colore Beige riverberano la luce nello spazio circostante, donando all'insieme un senso di rilassante accoglienza che invita alla convivialità. Di grande interesse, per l'aspetto naturale, sono le proposte da esterno, 22,5x22,5 cm e 22,5x45 cm.

Dans le patio ensoleillé, les tons chauds de la variante de couleur Beige reflètent la lumière dans l'espace alentour, offrant à l'ensemble un aspect accueillant et reposant, favorisant la convivialité. Les propositions d'extérieur, 22,5x22,5 cm et 22,5x45,3 cm, sont très intéressantes pour leur aspect naturel.

In der sonnigen Terrasse reflektieren die warmen Töne der Farbvariante Beige das Licht in der Umgebung und geben dem Ganzen ein Gefühl von entspannendem Empfang, der zur Geselligkeit einlädt. Von großem Interesse sind aufgrund der natürlichen Optik die Vorschläge für den Außenbereich in den Formaten 22,5x22,5 cm und 22,5x45,3 cm.

En el patio soleado, los tonos cálidos de la variante de color Beige reflejan la luz en el espacio circundante, otorgando al conjunto una sensación de relajante hospitalidad que invita a la convivencia. Las propuestas para exterior (22,5x22,5 cm y 22,5x45,3 cm) ofrecen gran interés por su aspecto natural.

В залитом солнцем patio теплые тона цвета Beige отражают свет в окружающее пространство, создавая атмосферу уюта, располагающую к приятному и беззаботному отдыху. Особый интерес благодаря своему естественному виду представляют решения, предлагаемые для наружных пространств - плиты форматов 22,5x22,5 см и 22,5x45,3 см.

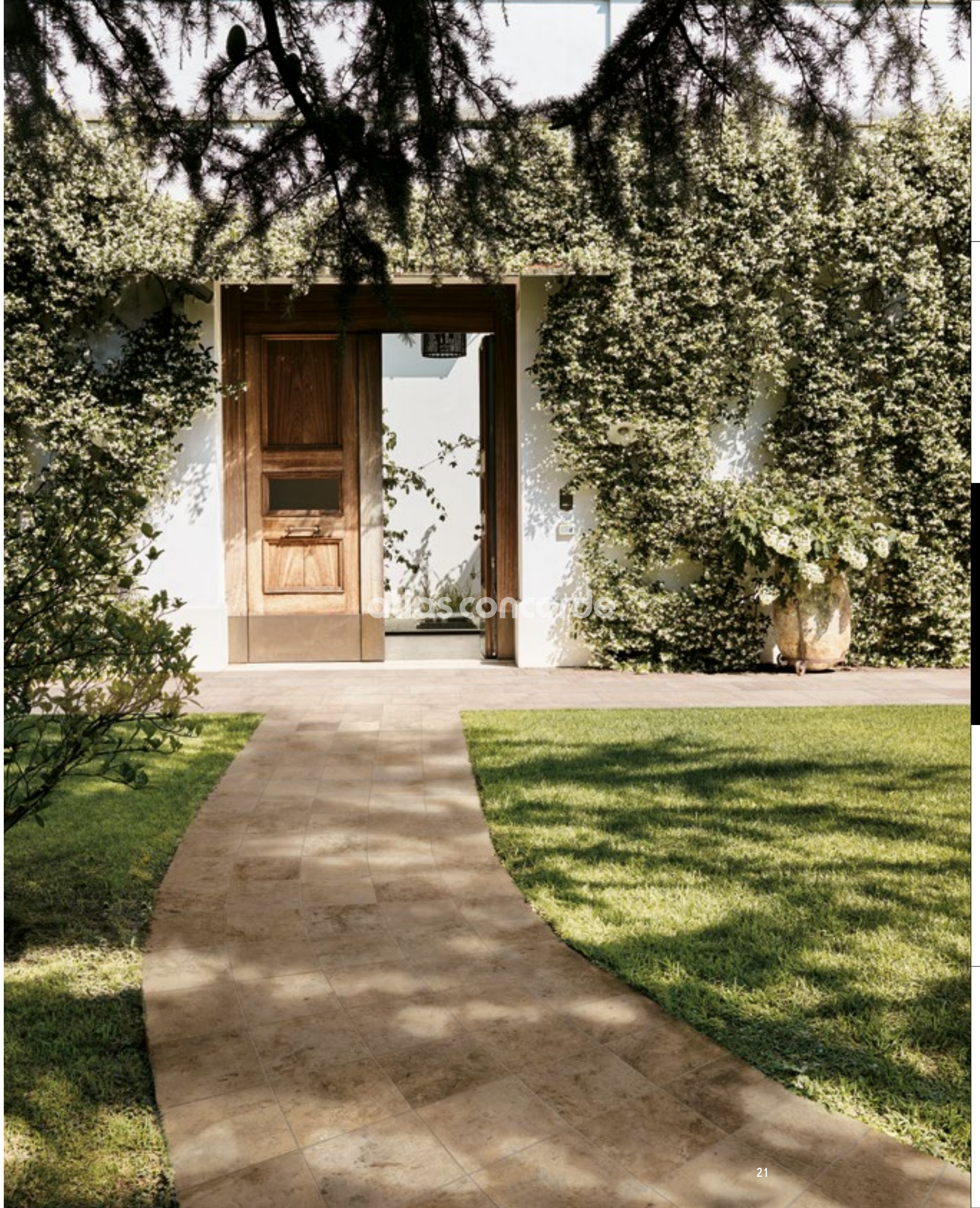



The antique effect of Aix stone, in the 20 mm thickness 60x90 cm size ($23\frac{5}{8}'' \times 35\frac{3}{8}''$), paired with special dedicated pieces for the pool edge, creates continuity between the natural elements of meadow, stone and water.

A masterful effect that enhances the pool in perfect stylistic uniformity with the rural context, ensuring the necessary performance for spaces characterized by the presence of water.

L'effetto antico della pietra di Aix, nel formato 60x90 cm a spessore 20 mm, in abbinamento ai pezzi speciali dedicati al bordo piscina, crea un percezione di continuità tra elementi della natura: prato, pietra e acqua. Un effetto passepartout che valorizza la piscina in perfetta uniformità stilistica con il contesto rurale, garantendo le performance necessarie per spazi caratterizzati dalla presenza di acqua.

L'effet ancien de la pierre de Aix, au format 60x90 cm de 20 mm d'épaisseur, associé aux pièces spéciales pour le bord de la piscine, crée une sensation de continuité entre les éléments naturels : gazon, pierre et eau. Un effet passe-partout qui met en valeur la piscine, en parfaite harmonie stylistique avec le cadre rural, tout en garantissant les performances nécessaires aux espaces comprenant de l'eau.

Die gealterte Optik des Aix-Steins im Format 60x90 cm mit einer Stärke von 20 mm, kombiniert mit den speziellen Formteilen für den Beckenrand, schafft eine Wahrnehmung der Kontinuität zwischen den Elementen der Natur: Rasen, Stein und Wasser. Ein Passepartout, der das Schwimmbad stilistisch perfekt dem ländlichen Kontext anpasst und die für nasse Umgebungen erforderliche Leistung gewährleistet.

El efecto antiguo de la piedra de Aix en formato de 60x90 cm y 20 mm de espesor, unido a las piezas especiales para el borde de la piscina, crea una sensación de continuidad entre los elementos de la naturaleza: campo, piedra y agua. El efecto paspartú realza la piscina a la vez que mantiene una uniformidad estilística perfecta con el entorno rural, lo que garantiza las prestaciones necesarias en espacios caracterizados por la presencia de agua.

Эффект старины камня, присущий плитам коллекции Aix формата 60x90 см толщиной 20 мм, в сочетании со специальными плитками для облицовки бортиков бассейна создает ощущение неразрывной связи природных элементов: травы, камня и воды. Такое обрамление создает эффект паспарту, усиливающий визуальное впечатление, создаваемое бассейном. С его помощью достигается совершенное стилистическое единство бассейна с окружающим сельским контекстом и одновременно удовлетворяются требования, предъявляемые к пространству, характеризующимся наличием воды.





The charm of yesteryear, vintage in style, characterizes some of the indoor spaces of the villa with the 37,5x75 cm (14³/₄"x29¹/₂") and 75x75 cm sizes (29¹/₂"x29¹/₂"), for a space in which the past marries with contemporary elements.

Il fascino dell'antico che rimanda ad uno stile vintage, caratterizza alcuni degli spazi indoor della villa attraverso i formati 37,5x75 cm, 75x75 cm della collezione, restituendo un ambiente in cui il passato convive con elementi contemporanei.

Le charme de l'ancien, dans un style un peu vintage, caractérise certains espaces intérieurs de la villa, à travers les formats 37,5x75 cm, 75x75 cm de la collection, offrant un cadre où le passé se marie aux éléments contemporains.

Der Charme der Antiquität, der sich auf einen Vintage-Stil bezieht, charakterisiert einige der Innenräume der Villa durch die Formate 37,5x75 cm, 75x75 cm der Kollektion und gestaltet die Umgebung gleichermaßen unter Einsatz von alten und zeitgenössischen Elementen.

El encanto de lo antiguo que recuerda al estilo «vintage» caracteriza algunos de los espacios interiores de la villa en los que se emplean los formatos 37,5x75 cm, 75x75 cm de la colección para crear un entorno en el que el pasado convive con elementos modernos.

Присущее стилю «винтаж» очарование древности создается в некоторых из внутренних помещений виллы благодаря использованию входящих в состав коллекции плит формата 37,5x75 см, 75x75 см, в результате образуется атмосфера, в которой прошлое гармонично сочетается с современными элементами.



atlas concorde

Selecting one size over another determines the personality of the space, its exclusivity, its uniqueness. The large 120x120 cm size (47 $\frac{1}{4}$ "x47 $\frac{1}{4}$ ") of Aix stands out for its geometric look and offers a harmonious contrast with the setting of this ancient villa with its contemporary atmosphere.

La scelta di un formato piuttosto che un altro determina la personalità dell'ambiente, la sua esclusività, la sua unicità. Il grande formato 120x120 cm di Aix caratterizza per il suo look geometrico e restituisce un armonioso contrasto con l'ambientazione di un'antica villa dall'atmosfera contemporanea.

Le choix d'un format ou d'un autre détermine la personnalité de l'environnement, son exclusivité, son caractère unique. Le grand format 120x120 cm d'Aix donne du cachet avec son look géométrique et offre un contraste harmonieux avec l'ambiance d'une ancienne villa, qui prend une coloration contemporaine.

La elección de un formato u otro determina la personalidad del ambiente, su exclusividad y su singularidad. El formato grande de 120x120 cm de Aix posee un diseño geométrico característico que produce un armonioso contraste con la ambientación de una antigua villa de aspecto moderno.

Die Wahl eines bestimmten Formats bestimmt die individuelle, exklusive und einzigartige Gestaltung der Umgebung. Das Großformat 120x120 cm von Aix zeichnet sich durch die geometrische Optik aus und bildet einen harmonischen Kontrast zur Umgebung einer alten Villa mit zeitgenössischer Atmosphäre.

Выбор формата в значительно большей степени чем другие факторы определяет лицо помещения, его эксклюзивность и уникальность. Крупный формат 120x120 см плит Aix создает неповторимый геометрический рисунок и образует гармоничный контраст, создавая в старинной вилле вполне современную атмосферу.



atlas concorde



atlas concorde

PATIO / WALKWAY
PORCELAIN TILES

Aix Beige Textured
22,5x45,3 cm | 8 7/8" x 17 3/4"

Aix Beige Textured
22,5x22,5 cm | 8 7/8" x 8 7/8"

Aix Beige Elemento L Strutturato
15x30 cm h.4 cm | 5 7/8" x 11 3/4" h. 1 5/8"

Aix Beige
22,5x22,5 cm | 8 7/8" x 8 7/8" ± 20 mm

POOL
PORCELAIN TILES

Aix Blanc
60x90 cm | 23 5/8" x 35 3/8" ± 20 mm

Aix Blanc Round
60x90 cm | 23 5/8" x 35 3/8"

Aix Blanc Round Ang.
60x90 cm | 23 5/8" x 35 3/8"

LIVING
PORCELAIN TILES

Aix Blanc Matte
75x75 cm | 29 1/2" x 29 1/2"

Aix Blanc Matte
37,5x75 cm | 14 3/4" x 29 1/2"

Aix Blanc Matte
120x120 cm | 47 1/4" x 47 1/4"

Mediterranean Mood

MEDITERRANEAN RESORT

A country house with an important past has been reimagined as an exclusive resort. Bright and welcoming spaces that open onto the Mediterranean countryside that surrounds them, where the barriers between internal and external spaces blur to the point of disappearing. A space/time continuity that is perfectly expressed by the Aix collection, the surfaces of which truly transmit the feel of old stone. Used across different applications, it always hits the right balance between style and performance.

Una dimora di campagna dal passato importante è stata reinterpretata come resort esclusivo. Ambienti luminosi e accoglienti, aperti sul paesaggio mediterraneo che le circonda, dove i confini tra spazi interni ed esterni sfumano fino a scomparire. Una continuità spazio-temporale perfettamente espressa dalla collezione Aix, le cui superfici trasmettono tutta la suggestione della pietra antica. Il suo impiego nelle diverse destinazioni d'uso, trova sempre la sintesi ottimale tra stile e prestazioni.

Une demeure de campagne au passé important a été reconvertie en résidence exclusive. Un cadre lumineux et accueillant, donnant sur le paysage méditerranéen qui l'entoure, où les limites entre intérieur et extérieur s'entremêlent jusqu'à disparaître. Une continuité spatiale et temporelle savamment exprimée par la collection Aix, dont les surfaces transmettent tout le charme de la pierre ancienne. Son emploi varié selon l'utilisation exprime toujours une synthèse parfaite entre style et performance.

Ein Landhaus mit einer wichtigen Vergangenheit wurde als exklusives Resort neu interpretiert. Helle und einladende Umgebungen, offen für die mediterrane Landschaft, die sie umgibt, wo die Grenzen zwischen Innen- und Außenräumen verblassen und manchmal sogar verschwinden. Eine Raum-Zeit-Kontinuität, die durch die Kollektion Aix perfekt zum Ausdruck kommt, deren Oberflächen alle Anspielungen eines alten Stein übertragen. In verschiedenen Anwendungen findet dieses Material immer die optimale Synthese zwischen Stil und Leistung.

Una antigua casa de campo importante se ha reconvertido en un exclusivo resort. Ambientes luminosos y acogedores, abiertos al paisaje mediterráneo que la circunda, donde los límites entre los espacios interiores y exteriores se difuminan hasta desaparecer. La colección Aix, cuyas superficies transmiten toda la fascinación de la piedra antigua, expresa a la perfección la continuidad espacial y temporal. Su empleo en distintas aplicaciones garantiza siempre una síntesis óptima entre estilo y prestaciones.

Сельская усадьба с богатым прошлым была превращена в эксклюзивный курорт. Светлые и уютные помещения с прекрасными видами на окружающий средиземноморский пейзаж, в которых границы между интерьерами и наружными пространствами размываются почти до полного исчезновения. Единство пространства и времени, идеально отражаемое плитами коллекции Aix, поверхности которых передают всю красоту старинного камня. Они могут применяться по различному назначению, неизменно обеспечивая идеальное сочетание стильного эстетического решения и эксплуатационных характеристик.







atlas concorde



atlas concorde

The appeal of stone marked by time and wear is modernized with a size designed to meet the needs of contemporary interior design. The 75x150 cm size (29½"x59"), installed using the running method, expresses a vision of architectonic space in line with the latest design trends.

Il fascino della pietra segnata dal tempo e dall'usura attualizzato da un formato pensato per le esigenze dell'interior design contemporaneo. Il 75x150 cm, posato a correre, è espressione di una concezione degli spazi architettonici al passo con le ultime tendenze progettuali.

Le charme de la pierre usée par le temps actualisé par un format conçu pour les exigences du design d'intérieur contemporain. Le format 75x150 cm, posé en décalé est l'expression d'une conception des espaces architecturaux alignée sur les dernières tendances.

Der Charme von durch die Zeit und Abnutzung geprägtem Naturstein wird durch ein Format wieder aktuell, das auf die Bedürfnisse des zeitgenössischen Innenausbau zugeschnitten ist. Das Format 75x150 cm wird in fortlaufender Verlegung zum Ausdruck eines architektonischen Raumkonzepts, das den neuesten Trends des Innendesigns folgt.

El encanto de la piedra desgastada por el paso del tiempo en un formato actual pensado para adecuarse a las exigencias del interiorismo moderno. El formato de 75x150 cm, colocado longitudinalmente, refleja la sintonía entre la concepción de los espacios arquitectónicos y las últimas tendencias en diseño.

Очарование камня со следами времени и износа, который приобрел новый облик благодаря формату, созданному в соответствии с требованиями современного дизайна интерьера. Плиты формата 75x150 см, уложенные в разбежку, служат выражением концепции отделки интерьеров, лежащей в русле самых последних дизайнерских тенденций.



Among the various decorations in the range, Brick Tumbled reinforces the collection's authentic flavor. The mosaic is tumbled, with an edging that recalls that of stones worn by time. With its characteristic size, it reinterprets a traditional installation to bring a modern twist and real dynamism to the design.

Tra i decori in gamma, il Brick Tumbled rafforza il sapore autentico della collezione. Il mosaico è burattato, ha una lavorazione sul bordo che richiama le pietre usurate dal tempo. Con il suo caratteristico formato, rilegge con gusto contemporaneo una posa tradizionale e dona dinamismo alla progettazione.

Parmi les décors de la gamme, le Brick Tumbled renforce le goût authentique de la collection. La mosaïque est tamisée, elle présente un façonnage sur le bord qui rappelle les pierres usées par le temps. Avec son format caractéristique, elle donne une touche contemporaine à une pose traditionnelle et offre du dynamisme à l'ensemble.

Unter den angebotenen Dekor, verstärkt Brick Tumbled den authentischen Geschmack der Kollektion. Das getrommelte Mosaik erinnert durch die spezielle Kantenverarbeitung an die durch die Zeit verschlissenen Steine. Mit seinem charakteristischen Format interpretiert es in zeitgenössischem Geschmack eine traditionelle Verlegung neu und verleiht dem Projekt Dynamik.

Entre las decoraciones disponibles, Brick Tumbled refuerza la auténtica estética de la colección. El labrado del borde del mosaico envejecido imita el desgaste de la piedra a lo largo del tiempo. Con su formato característico, reinterpreta la instalación tradicional en clave moderna y aporta dinamismo al diseño.

Среди имеющихся вариантов отделки выделяется Brick Tumbled, который усиливает аутентичный характер коллекции. Мозаика выполнена из галтованных элементов, а их края подвергнуты специальной обработке, создающей эффект старинного камня с многочисленными отметинами, оставленными временем. Её характерный формат позволяет в современном ключе воспроизвести традиционную укладку и придать дизайну особый динамизм.







atlas concorde



atlas concorde

In the corridor to the spa, the offset installation of the 37.5x75 cm size (14³/₄"x29¹/₂") amplifies the perception of space and brings a sense of perspective to the design. A lively style and character at the service of the contemporary spaces dedicated to physical and mental well-being.

Nel corridoio della spa, la posa sfalsata del formato 37,5x75 cm amplifica la percezione dello spazio e infonde senso prospettico alla progettazione. Stile vivace e carattere al servizio degli spazi contemporanei dedicati al benessere del corpo e della mente.

Dans le couloir du spa, la pose décalée du format 37,5x75 cm amplifie la perception de l'espace et donne de la profondeur à ce projet. Style vif, caractère fort, au service des espaces contemporains dédiés au bien-être du corps et de l'esprit.

Im Flur des Spa verstärkt die versetzte Verlegung des Formats 37,5x75 cm die Wahrnehmung des Raumgefühls und verleiht dem Design einen perspektivischen Charakter. Lebhafter Stil und Charakter im Dienste zeitgenössischer Räume, die dem Wohlbefinden von Körper und Geist gewidmet sind.

En el pasillo del spa, la instalación escalonada del formato de 37,5x75 cm amplía la percepción espacial y otorga perspectiva al diseño. Estilo dinámico y carácter al servicio de los espacios actuales destinados al bienestar del cuerpo y de la mente.

Уложенные в разбежку в коридоре СПА-салона плитки формата 37,5x75 см визуально увеличивают объем пространства и способствуют созданию эффекта перспективы. Стиль, идеально гармонирующий с характером современных помещений, предназначенных для создания комфорта для тела и духа.



Great compositional freedom

With their textured surface, the two sizes - 22.5x45.3 cm (8⁷/₈"x17³/₄") and 22.5x22.5 cm (8⁷/₈"x8⁷/₈") - are specifically designed for use in outdoor environments. They allow for the creation of various modules and installation solutions, bringing practicality, performance and character to contemporary hospitality spaces.

I due formati - 22,5x45,3 cm e 22,5x22,5 cm - dalla superficie strutturata, sono appositamente dedicati per un utilizzo in ambienti outdoor. Consentono di realizzare svariati moduli e soluzioni di posa, coniugando praticità, prestazioni e carattere nei luoghi dell'ospitalità contemporanei.

Les deux formats - 22,5x45,3 cm et 22,5x22,5 cm - à la surface texturisée, sont parfaits pour l'utilisation en extérieur. Ils permettent de réaliser différents modules et solutions de pose, alliant commodité, performance et caractère, dans les établissements d'accueil contemporains.

Los dos formatos (22,5x45,3 cm y 22,5x22,5 cm) de superficie estructurada están expresamente diseñados para utilizarse en exteriores. La posibilidad de combinar varios módulos y soluciones de instalación garantiza prestaciones, a la vez que imprime sentido práctico y carácter a las instalaciones hoteleras modernas.

Die beiden Formate - 22,5x45,3 cm und 22,5x22,5 cm - mit strukturierter Oberfläche sind der Outdoor-Verlegung gewidmet. Sie ermöglichen verschiedene Module und Verlegelösungen und vereinen Funktionalität, Leistung und Charakter für moderne Gastfreundlichkeit.

Плиты обоих форматов - 22,5x45,3 см и 22,5x22,5 см имеют структурированную поверхность и специально предназначены для использования в наружных пространствах. Они позволяют использовать различные сочетания и способы укладки, совмещая такие свойства как практичность, высокие эксплуатационные характеристики и внешний вид, идеально подходящий для современных центров отдыха и приема гостей.



atlas concorde



atlas concorde

A porcelain tile collection inspired by the beauty of things transformed by time. Materials with a seasoned appearance that create a strong link between the living space and nature, adding emotional value to architectonic projects.

Una collezione in gres porcellanato ispirata alla bellezza delle cose trasformate dal tempo. Materiali dall'aspetto vissuto che creano un forte legame tra spazio abitativo e natura, dando valore emozionale ai progetti architettonici.

Une collection en grès cérame qui s'inspire de la beauté des objets transformés par le temps. Matériaux à l'aspect vécu qui créent un lien important entre espace de vie et nature, offrant une touche d'émotion aux projets architecturaux.

Eine Feinsteinzeugkollektion, die sich am Schönen inspiriert und die Spuren der Zeit trägt. Gelebte Materialien, die eine starke Verbindung zwischen Lebensraum und Natur herstellen und Architekturprojekten einen emotionalen Wert verleihen.

Una colección en gres porcelánico inspirada en la belleza de las cosas transformadas por el tiempo. Materiales de aspecto envejecido que, además de crear un fuerte vínculo entre el espacio habitable y la naturaleza, otorgan valor emocional a los diseños arquitectónicos.

Коллекция плит из керамогранита, вдохновленная красотой вещей, преобразованных временем. Материалы с эффектом под старину, которые создают прочную связь между пространствами жилых помещений и окружающей природой, придавая архитектурным проектам дополнительную эмоциональную окраску.



atlas concorde



ATLAS CONCORDE OFFERS AN ELEGANT METAL TAG FOR THOSE WHO WANT TO MARK SURFACES WITH A BRAND THAT STANDS FOR PRESTIGE AND QUALITY INSPIRED BY INTERNATIONAL DESIGN.

ATLAS CONCORDE METTE A DISPOSIZIONE UNA ELEGANTE ETICHETTA IN METALLO PER CHI VOGLIA CONTRASSEGNARE LE SUPERFICI CON UN MARCHIO DI PRESTIGIO E QUALITÀ, ISPIRATO AL DESIGN INTERNAZIONALE.



atlas concorde



atlas concorde

RECEPTION
PORCELAIN TILES

Aix Beige Matte
75x150 cm | 29 1/2"x59"

Aix Beige Matte
75x75 cm | 29 1/2"x29 1/2"

Aix Beige Matte
37,5x75 cm | 14 3/4"x29 1/2"

Aix Beige Brick Tumbled
37x37 cm | 14 5/8"x14 5/8"

OUTDOOR CORNER
PORCELAIN TILES

Aix Beige Textured
22,5x45,3 cm | 8 7/8"x17 3/4"

Aix Beige Textured
22,5x22,5 cm | 8 7/8"x8 7/8"

Aix Beige Matte
37,5x75 cm | 14 3/4"x29 1/2"

Aix Beige Brick Tumbled
37x37 cm | 14 5/8"x14 5/8"



atlas concorde

Total White

Material and tactile harmonies warm the wellness area thanks to the use of a cosy and bright color like Blanc, which stars in the space both in the cladding, with Row three-dimensional relief, and the flooring, with the multi-size tumbled kit.

Armonie materiche e tattili scaldano l'ambiente wellness grazie alla scelta di un colore caldo e luminoso come il Blanc, che diventa protagonista dello spazio sia a rivestimento, con il rilievo tridimensionale Row, che a pavimento con il kit multiformato Tumbled.

Les matières harmonieuses et tactiles rendent l'espace bien-être accueillant, grâce à une couleur chaude et lumineuse telle que le blanc, qui est au centre de cet environnement – dans les revêtements, avec le relief tridimensionnel Row, et au sol, avec le kit multiformat Tumbled.

Armonías materiales y táctiles que aportan calidez a los espacios de «wellness» gracias a la elección de un color cálido y luminoso como el Blanc, que se convierte en protagonista del espacio como revestimiento, con el relieve tridimensional Row, y como pavimento con el kit Tumbled multiformato.

Materielle und taktile Harmonien erwärmen das Wellness-Umfeld dank der Wahl einer warmen und hellen Farbe wie Blanc, die zum Protagonisten des Raumes wird, sowohl für Wandfliesen mit dem dreidimensionalen Relief Row, als auch für Böden mit dem Multiformat-Set Tumbled.

Гармония визуальных и тактильных ощущений придает особую теплоту велнес-зоне благодаря выбору теплого и светлого оттенка белого цвета Blanc для плит, примененных для отделки как стен – в исполнении с трехмерным рельефом Row, так и пола – с использованием разноформатного комплекта Tumbled.



atlasconcorde

The multi-size Tumbled module reinstates the sense of unevenness and imperfection typical of tumbled materials. The authentic effect of porcelain tile is thus accentuated, recalling the original reclaimed stone.

Il modulo multiformato Tumbled restituisce le sensazioni di ruvidezza e imperfezione tipiche dei materiali burattati. Viene così accentuato l'effetto di autenticità del gres porcellanato che richiama la pietra di recupero originale.

Le module multiformat Tumbled offre les sensations de rugosité et d'imperfection typiques des matériaux tamisés. C'est ainsi que l'effet authentique du grès cérame rappelle la pierre de récupération originale.

Das Multiformat-Modul Tumbled liefert die für getrommelte Materialien typischen Empfindungen von Rauheit und Unvollkommenheit. Hiermit wird die echte Seele des Feinsteinzeugs zum Ausdruck gebracht und die Idee der Wiederverwertung des Steins erweckt.

El módulo multiformato Tumbled recupera la sensación de rugosidad e imperfección que son típicas de los materiales con acabado envejecido. De esta manera se resalta la autenticidad del gres porcelánico, que trae a la memoria la piedra recuperada original.

Разноформатный комплект Tumbled вызывает ощущения шероховатости и неровности, типичные для галтованного камня. Это подчеркивает эффект аутентичности, создаваемый керамогранитом, воспроизводящим вид оригинального камня.



atlasconcorde



atlas concorde



atlas concorde

3D Row adds an appealing three-dimensional touch to wall tiles in bathroom and spa spaces, lending itself to the creation of designs with a modern geometric accent.

La struttura 3D Row infonde un affascinante tocco tridimensionale ai rivestimenti degli ambienti bagno e spa, prestandosi alla realizzazione di pattern caratterizzati da un moderno accento geometrico.

3D Row donne une touche tridimensionnelle fascinante aux revêtements de la salle de bains et du spa, permettant de créer des motifs caractérisés par un style géométrique moderne.

3D Row verleiht den Verkleidungen von Badezimmern und Spas eine faszinierende dreidimensionale Note und ermöglicht Muster, die sich durch einen modernen geometrischen Akzent auszeichnen.

3D Row confiere un fascinante toque tridimensionale a los revestimientos de los ambientes de baño y spa, permitiendo componer patrones caracterizados por su moderno aspecto geométrico.

3D Row придает восхитительный трехмерный эффект облицовке стен ванных комнат и СПА-зон, позволяя создавать геометрические формы, характерные для современных тенденций дизайна интерьера.



atlas concorde



atlas concorde

BATHROOM
WALL TILES

Aix Blanc Matte
40x80 cm | 15 3/4" x 31 1/2"

Aix 3D Row Blanc Matte
40x80 cm | 15 3/4" x 31 1/2"

Aix Blanc Corner Matte
1,4x40 cm | 5/8" x 15 3/4"

Aix 3D Blanc Corner Matte
1,4x40 cm | 5/8" x 15 3/4"

Aix Blanc Corner A.E. Matte
1,4x1,4 cm | 5/8" x 5/8"

PORCELAIN TILES

Aix Blanc Matte
Kit Multifornato Tumbled

Aix Blanc Matte
75x150 cm | 29 1/2" x 59"

Inspired by Northern Europe

ANCIENT VILLA

An ancient villa immersed in greenery has been restructured with contemporary appeal. Furniture and objects elegant in design flank architectonic elements that retain the traces of an important past.

This can also be seen on the reclaimed stone-effect surfaces of Aix, a collection characterized by its seasoned appearance but that is also extremely functional, satisfying the latest interior design needs.

Una villa antica immersa nel verde è stata ristrutturata con appeal contemporaneo. Arredi e oggetti dal design sobrio ed elegante convivono con elementi architettonici che conservano le tracce di un passato importante e che ritorna anche nelle superfici effetto pietra recuperata di Aix, una collezione dal caratteristico aspetto vissuto e, al tempo stesso, estremamente funzionale alle nuove esigenze di interior.

Une villa ancienne plongée dans la verdure a été restaurée dans le goût contemporain. Ameublements et objets au design sobre et élégant s'allient à des éléments architecturaux qui gardent les traces d'un passé important, qu'on retrouve dans les surfaces effet pierre récupérée de Aix, une collection à l'aspect typiquement vécu, tout en restant extrêmement adaptée aux nouvelles exigences de l'intérieur.

Eine antike Villa mitten im Grünen wurde mit zeitgenössischem Charme renoviert. Möbel und Gegenstände mit nüchternem und elegantem Design neben architektonischen Elementen, die die Spuren einer wichtigen Vergangenheit bewahren und die auch in den wiederhergestellten Steinoptik-Oberflächen von Aix einer Kollektion mit einem charakteristischen Wohnaussehen zu finden sind und gleichzeitig äußerst funktional an die neuen Bedürfnisse des Innenraums angepasst werden.

La villa antigua rodeada de vegetación se ha restaurado en clave actual. El mobiliario y los objetos de diseño sobrios y elegantes conviven con elementos arquitectónicos que conservan las huellas de un pasado importante, que se refleja también en las superficies de efecto piedra recuperada de Aix, una colección que posee un característico aspecto envejecido y que, al mismo tiempo, resulta extremadamente funcional según los nuevos requisitos del interior.

Старинная вилла, утопающая в зелени, была перестроена в современном ключе. Предметы обстановки со строгим и элегантным дизайном сочетаются с архитектурными элементами, которые еще хранят следы исторического прошлого, воспроизведенные также на поверхностях, облицованных плитами из восстановленного камня из коллекции Aix. Ее характерной чертой является сочетание эффекта старины с максимальным соответствием новым функциональным требованиям, предъявляемым к интерьеру.





atlas concord

INDEX

OVERVIEW

SPACES

RANGE

TECH. SPECS



For a space with a modern look that reflects the atmosphere of the ancient dwelling. This design need led to the decision to go with an installation that combines the 75x150, 75x75 and 37.5x75 cm sizes (29½"x59", 59"x59", 14¾"x29½") in the suggestive cool shade of Cendre.

Creare uno spazio dal look moderno dove si rispecchia l'atmosfera dell'antica dimora. Nasce da questa esigenza progettuale la scelta di utilizzare la posa combinata dei formati 75x150, 75x75 e 37,5x75 cm nella suggestiva variante della nuance fredda Cendre.

Créer un espace au look moderne où l'on retrouve l'atmosphère de la demeure ancienne. Cette exigence conceptuelle a poussé vers le choix de la pose combinée des formats 75x150, 75x75 et 37,5x75 cm dans la variante pittoresque de la nuance froide Cendre.

Es geht darum, einen Raum mit einem modernen Look zu schaffen, in dem sich die Atmosphäre der alten Residenz widerspiegelt. Diese konstruktive Anforderung führte zur Entscheidung, die kombinierte Installation der Formate 75x150, 75x75 und 37,5x75 cm in der suggestiven Variante der kalten Nuance Cendre zu wählen.

Crear un espacio de aspecto moderno que refleje la atmósfera de la casa antigua. La decisión de combinar los formatos de 75x150, 75x75 y 37,5x75 cm en la atractiva variante de Cendre en tonos fríos es fruto de este requisito de diseño.

Создать пространство с современным обликом, сохраняющее атмосферу старинной резиденции. Это поставленное перед проектировщиками требование и определило сделанный ими выбор: использование комбинации плит форматов 75x150, 75x75 и 37,5x75 см в приятном варианте холодного цвета Cendre.



atlas concorde



atlas concorde

The staggered laying of slabs in the 37,5x75 cm size (14³/₄"x29¹/₂") amplifies the perception of space and draws attention to the clouding, markings and other signs of wear typical of reclaimed stone, which chase and alternate with each other across the surfaces of the Aix collection.

La posa sfalsata delle lastre nel formato 37,5x75 cm amplia la percezione degli spazi e orienta lo sguardo verso le nuvolature, le macchie e gli altri segni di usura tipici della pietra di recupero che si rincorrono e alternano sulle superfici della collezione Aix.

La pose décalée des dalles au format 37,5x75 cm amplifie la perception des espaces et oriente le regard vers les nuances, taches et autres traces d'usure typiques de la pierre de récupération qui alternent sur les surfaces de la collection Aix.

Die versetzte Verlegung der Platten im Format 37,5x75 cm erweitert die Raumwahrnehmung und lenkt den Blick auf die für Recycling-Steine typischen Wolken, Flecken und anderen Verschleißerscheinungen, die auf den Oberflächen der Kollektion Aix zu erkennen sind.

La instalación escalonada de las placas con formato de 37,5x75 cm amplía la percepción espacial y dirige la atención a las sombras, las manchas y otras marcas de desgaste típicas de la piedra recuperada, que se persiguen y alternan en las superficies de la colección Aix.

Укладка вразбежку плит формата 37,5x75 см визуально расширяет пространство и направляет взгляд на цветовые переходы, пятна и другие следы износа, типичные для восстановленного камня, повторяющиеся и чередующиеся на поверхности плит, входящих в состав коллекции Aix.



atlas concorde



atlas concorde



atlas concorde

A room with clean, modern lines in a context of restoration, the floor of which, featuring the Fumée color variant from the Aix ceramics collection, transmits the flavor of antique things, embellished with the passage of time.

Una camera dalle linee essenziali e moderne in un contesto di recupero che anche a pavimento, con la variante di colore Fumée della collezione ceramica Aix, trasmette il sapore delle cose antiche, impreziosite dal passare del tempo.

Une chambre aux lignes épurées et modernes dans un cadre de récupération qui, même dans le sol, avec la variante de couleur Fumée de la collection céramique Aix, transmet le goût de l'ancien, qui devient riche avec le temps qui passe.

Ein Raum mit essentiellen und modernen Linien in einem Kontext der Wiederverwertung, der auch auf dem Boden, mit der Farbvariante Fumée der Keramikkollektion Aix, den Geschmack alter Umgebungen vermittelt, die durch die Spuren der Zeit verschönert werden.

Una habitación de líneas esenciales y modernas en un contexto de recuperación que también en el suelo, con la variante de color Fumée de la colección cerámica Aix, transmite el sabor de las cosas antiguas, cuya belleza aumenta con el paso del tiempo.

Спальня со строгими и современными линиями, выполненная в духе бережного обращения к прошлому, которая, в том числе благодаря полу, облицованному плитками цвета Fumée из керамической коллекции Aix, передает очарование старинных вещей, приобретенное ими с течением времени.



LIVING
PORCELAIN TILES

- Aix Cendre Matte**
75x150 cm | 29 1/2"x59"
- Aix Cendre Matte**
75x75 cm | 29 1/2"x29 1/2"
- Aix Cendre Matte**
37,5x75 cm | 14 3/4"x29 1/2"

BEDROOM
PORCELAIN TILES

- Aix Fumée Matte**
37,5x75 cm | 14 3/4"x29 1/2"

DINETTE
PORCELAIN TILES

- Aix Fumée Matte**
75x75 cm | 29 1/2"x29 1/2"

In connection with the landscape

MANOR HOUSE

In rural European landscapes, the living culture speaks of a strong connection between humankind and the land. Testament to this are those architectures characterized by large glass panels and windows, for spaces that are as open as possible, bathed in light.

The living spaces look out on to countryside that perfectly reflects inside the room, defining its character. The use of the Aix collection, inspired by reclaimed stone, reinforces the sensation of a story, deeply rooted in time and fitting perfectly with the natural environment.

Nei paesaggi rurali europei la cultura abitativa parla di un forte legame tra uomo e territorio. Lo testimoniano architetture caratterizzate da vetrate e finestre di grandi dimensioni, per rendere gli ambienti il più possibile aperti, inondati di luce.

Gli spazi abitativi sono affacciati su un paesaggio che si riflette idealmente al loro interno, definendo il loro carattere. L'impiego della collezione Aix, ispirata alla pietra di recupero, rafforza la sensazione di una storia radicata nel tempo, perfettamente integrata nell'ambiente naturale.

Dans les paysages ruraux européens, la culture du foyer évoque un lien fort entre l'homme et le territoire. Pour en témoigner, les architectures caractérisées par des baies vitrées et de grandes fenêtres ouvrent les pièces et les baignent le plus possible de lumière. Les espaces de vie donnent sur un paysage qui se reflète idéalement à l'intérieur, définissant leur caractère. L'emploi de la collection Aix, qui s'inspire de la pierre de récupération, renforce la sensation d'une histoire enracinée dans le temps, parfaitement intégrée dans le cadre naturel.

In den ländlichen Gebieten Europas spricht die Wohnkultur von einer starken Verbindung zwischen Mensch und Gebiet. Davon zeugt die Architektur mit großen Glaswänden und Fenstern, damit Räume so offen und lichtdurchflutet wie möglich gestaltet werden können. Die Lebensräume blicken auf eine Landschaft, die sich in ihnen ideal widerspiegelt und ihren Charakter definiert. Die Verwendung der Kollektion Aix, inspiriert von recyceltem Stein, verstärkt das Gefühl einer Geschichte, die in der Zeit verwurzelt ist und sich perfekt in die natürliche Umgebung integriert.

En los paisajes rurales europeos, la cultura habitacional evidencia una estrecha relación entre el hombre y la tierra. Testimonio de esto son las obras arquitectónicas con grandes cristalerías y ventanas que permiten crear ambientes tan abiertos e inundados de luz como sea posible. Las viviendas se asoman a un paisaje que refleja conceptualmente su interior y definen su carácter. El empleo de la colección Aix, inspirada en la piedra recuperada, refuerza la sensación de historia arraigada en el tiempo y perfectamente integrada en el entorno natural.

Европейские сельские пейзажи характеризуются такой архитектурой жилых зданий, которая подчеркивает прочную связь между человеком и окружающей территорией. Свидетельством такого подхода к архитектуре являются большие застекленные поверхности и окна, делающие помещения максимально открытыми и заполненными светом. Из жилых комнат открывается вид на пейзаж, который отражается внутри них, придавая им свое собственное лицо. Использование плит из коллекции Aix, вдохновленной образами восстановленного камня, усиливает ощущение причастности к истории, находящейся в полной гармонии с окружающей природой.



atlas concorde





In the Cendre color, the 20 mm thick 120x120 cm size (47¹/₄"x47¹/₄"") is ideal for the creation of walkways, driveways and other outdoor design solutions characterized by the seasoned elegance of reclaimed stone.

Nel colore Cendre, il formato 120x120 cm a spessore 20 mm si presta alla perfezione per realizzare camminamenti, aree carrabili e altre soluzioni progettuali outdoor caratterizzate dall'eleganza vissuta della pietra recuperata.

Dans la couleur Cendre, le format 120x120 cm de 20 mm d'épaisseur est parfait pour réaliser des chemins, zones de passage et autres solutions de conception d'extérieur qui ont l'élégance vécue de la pierre récupérée.

En color Cendre, el formato de 120x120 cm y 20 mm de espesor es excelente para pasarelas, calzadas y otras soluciones de diseño exterior caracterizadas por la elegancia vivida de la piedra recuperada.

In der Farbe Cendre eignet sich das Format 120x120 cm mit einer Stärke von 20 mm perfekt für die Gestaltung von Gehwegen, Eingängen und anderen Outdoor-Design-Lösungen, die sich durch die gelebte Eleganz von Naturstein auszeichnen.

Плиты цвета Cendre с форматом 120x120 см и толщиной 20 мм идеально подходят для создания пешеходных дорожек, подъездных путей и других дизайнерских решений для наружных пространств, характеризующихся элегантным эффектом старины, создаваемым восстановленным камнем.



atlas concorde

The 22.5x22.5 cm (8⁷/₈"x8⁷/₈"") and 22.5x45.3 cm sizes (8⁷/₈"x17³/₄"") with textured finish ensure installation freedom, maximum aesthetic continuity between indoor and outdoor spaces, and an extraordinary resistance to atmospheric agents.

I formati 22,5x22,5 cm e 22,5x45,3 cm con finitura strutturata assicurano un'ampia libertà di posa, la massima continuità estetica tra ambienti interni ed esterni e una straordinaria resistenza agli agenti atmosferici.

Les formats 22,5x22,5 cm et 22,5x45,3 cm avec finition texturisée garantissent une grande liberté de pose, une excellente continuité esthétique entre intérieur et extérieur et une extraordinaire résistance aux agents atmosphériques.

Los formatos de 22,5x22,5 cm y 22,5x45,3 cm con acabado estructurado garantizan una gran libertad de instalación, la máxima continuidad estética entre los ambientes de interior y exterior y una resistencia a los agentes atmosféricos extraordinaria.

Die Formate 22,5x22,5 cm und 22,5x45,3 cm mit strukturierter Oberfläche gewährleisten eine große Verlegefreiheit, maximale ästhetische Kontinuität zwischen Innen- und Außenbereich und eine außergewöhnliche Witterungsbeständigkeit.

Плиты форматов 22,5x22,5 см и 22,5x45,3 см со структурированной поверхностью обеспечивают широкую свободу укладки, максимальное стилистическое единство внутренних и наружных пространств и чрезвычайную стойкость к воздействию атмосферных факторов.



atlas concorde



atlas concorde

GATEWAY
PORCELAIN TILES

Aix Cendre
120x120 cm | 47 1/4"x47 1/4" ± 20 mm
60x90 cm | 23 5/8"x35 3/8" ± 20 mm

YARD
PORCELAIN TILES

Aix Cendre Textured
22,5x45,3 cm | 8 7/8"x17 3/4"
Aix Cendre Textured
22,5x22,5 cm | 8 7/8"x8 7/8"
Aix Cendre Elemento L. Strutturato
15x30 cm h.4 cm | 5 7/8"x11 3/4" h. 15/8"



Clean lines and the uniformity of a surface. The 120x120 cm (47 $\frac{1}{4}$ "x47 $\frac{1}{4}$ ") outdoor size of Aix finds perfect application in this relaxation corner, becoming a part of the project, in line with landscape architecture requirements.

Linee pulite e uniformità della superficie. Il formato 120x120 cm da esterno di Aix trova la sua perfetta collocazione in questo angolo di relax e diventa parte del progetto in linea con le esigenze della landscape architecture

Lignes nettes et surface uniforme. Le format 120x120 cm d'extérieur Aix trouve parfaitement sa place dans ce coin détente, s'insérant dans un projet qui répond aux exigences de l'architecture paysagiste.

Klare Linien und Gleichmäßigkeit der Oberfläche. Das Format 120x120 cm für den Außenbereich der Kollektion Aix eignet sich bestens für diese Entspannungsecke und wird Teil des Projekts, das den Bedürfnissen der Landschaftsarchitektur entspricht.

Líneas limpias y superficie uniforme. El formato de 120x120 cm para exterior de Aix es perfecto para este lugar de descanso y se convierte en parte del diseño según las exigencias de la arquitectura paisajística.

Чистые линии и однородность поверхности. Плиты формата 120x120 см для наружных пространств Aix великолепно вписываются в этот тихий уголок и становятся неотъемлемой частью дизайна в соответствии с требованиями ландшафтной архитектуры.



The installation that can be created with the 120x120 cm size (47¹/₄"x47¹/₄") is the ideal way to lend contemporary living spaces a modern look. This allows for the creation of geometric spaces in harmony with the architectonic and design elements that characterize them.

La posa realizzabile con il formato 120x120 cm è ideale per conferire un look moderno agli spazi dei living contemporaneo. Consente di disegnare spazi geometrici in armonia con gli elementi architettonici e di design che li caratterizzano.

La pose réalisable avec le format 120x120 cm est parfaite pour donner un look moderne aux espaces du salon contemporain. Elle permet de créer des espaces géométriques en harmonie avec les éléments architecturaux et design qui les caractérisent.

Durch die Verlegung des Formats 120x120 cm wird den zeitgemäßen Living-Bereichen ein moderner Look verliehen. Es ermöglicht die Gestaltung geometrischer Räume in Harmonie mit den charakterisierenden Architektur- und Designelementen.

La instalación del formato de 120x120 cm es perfecta para dar una imagen moderna a los espacios habitables actuales. Permite diseñar espacios geométricos que armonizan con los elementos arquitectónicos y de diseño que los caracterizan.

Укладка, выполненная с использованием плит формата 120x120 см, идеально подходит для придания современного облика комнатам сегодняшнего дома. Она позволяет создавать геометрические пространства, гармонирующие с используемыми в них архитектурными и дизайнерскими элементами.



atlas concorde

Relaxing vibes

A bathroom space created with the cool tones of the Cendre color, using the 40x80 cm size (15³/₄"x31¹/₂"), in the normal and 3D versions for the cladding, and the modern and functional 75x75 cm size (29¹/₂"x29¹/₂") for the flooring. A tactile approach, inspired by the beauty of reclaimed stone, for a blend of old and new that generates an intense feeling of well-being.

Un ambiente bagno realizzato con il colore Cendre, dalle tonalità fredde, utilizzando il formato 40x80 cm, nelle versioni normali e 3D a rivestimento, e il moderno e funzionale formato 75x75 cm a pavimento. Attitudine tattile e materica, ispirata alla bellezza della pietra di recupero, per un mix tra antico e contemporaneo che genera intense vibrazioni di benessere.

Une salle de bains réalisée avec la couleur Cendre, aux tons froids, en exploitant le format 40x80 cm, dans les versions normales et 3D de revêtement, et le moderne et fonctionnel format 75x75 cm au sol. Une allure tactile et matérielle, s'inspirant de la beauté de la pierre de récupération, pour un mélange entre ancien et contemporain qui offre d'intenses vibrations de bien-être.

Un baño realizado en tonos fríos de color Cendre utilizando el formato de 40x80 cm en versiones normal y 3D con revestimiento, y el formato de 75x75 cm moderno y funcional en el suelo. Actitud táctil y matériera, inspirada en la belleza de la piedra recuperada para ofrecer una mezcla de antigüedad y modernidad que genera intensas vibraciones de bienestar.

Eine Badezimmergestaltung mit der Farbe Cendre, kalte Töne im Format 40x80 cm, in den herkömmlichen Versionen und 3D an der Wand, und mit dem modernen und funktionalen Format 75x75 cm für die Bodenflächen. Eine taktile und materielle Haltung, inspiriert von der Schönheit von recyceltem Stein, für eine Mischung aus Alt und Neu, die intensive Schwingungen des Wohlbefindens erzeugt.

Ванная комната, выполненная в цвете Cendre с холодной тональностью с использованием настенных плит формата 40x80 см в обычном и 3D-исполнениях и напольных плит современного и функционального формата 75x75 см. Внешний вид и тактильное решение, вдохновленные красотой восстановленного камня, способствуют созданию микса старины и современности, вызывающего ощущение глубокого комфорта.



atlas concorde



atlas concorde

Clad with the 40x80 cm size (15³/₄"x31¹/₂") that favors the natural appearance of stone, and combined with the 3D 40x80 cm size (15³/₄"x31¹/₂"), this three-dimensional surface is inspired by chiseled stone so as to achieve parallel lines, perfect for decorating defined areas of the bathroom space.

Rivestito con il formato 40x80 cm che privilegia l'aspetto naturale della pietra e combinato con il 40x80 cm 3D, una superficie tridimensionale ispirata a una pietra cesellata in modo da ottenere linee parallele, perfetta per decorare aree definite dell'ambiente bagno.

Le revêtement au format 40x80 cm privilégie l'aspect naturel de la pierre, combiné avec le 40x80 cm 3D: une surface tridimensionnelle s'inspirant d'une pierre ciselée jusqu'à obtenir des lignes parallèles, parfaite pour décorer des zones particulières de la salle de bains.

Der Belag im Format 40x80 cm im Erscheinungsbild von Naturstein, kombiniert mit dem Format 40x80 cm in der dreidimensionalen Ausführung, die sich am gemeißelten Stein inspiriert und parallele Linien bildet, die sich perfekt zum Dekorieren definierter Bereiche des Badezimmers eignen.

Revestido con el formato de 40x80 cm que realza el aspecto natural de la piedra y combinado con el formato de 40x80 cm 3D, una superficie tridimensional inspirada en la piedra cincelada para obtener líneas paralelas y que resulta perfecta para decorar áreas concretas de la zona de baño.

Настенные плиты формата 40x80 см, подчеркивающие естественный облик камня, в сочетании с плитками формата 40x80 см в 3D-исполнении образуют трехмерную поверхность, вдохновленную видом камня, обтесанного для получения строго параллельных линий, которая замечательно подходит для декорирования бросающихся в глаза участков ванной комнаты.



atlas concorde



atlas concorde

On the floor, the 75x75 cm size (29½"x29½") adds to the Nordic light living mood, the inspiration for the bathroom area, giving guests the feeling that they are inside their own personal comfort zone.

Il formato 75x75 cm, a pavimento completa il mood dal fascino nordico light living, lo stile a cui si ispira l'area bagno, per suscitare negli ospiti la percezione di essere all'interno della loro comfort zone personale.

Le format 75x75 cm, au sol complète l'ambiance charme nordique light living, style auquel s'inspire la salle de bains, pour susciter chez les hôtes la sensation d'être à l'intérieur de leur zone de confort personnelle.

Das Format 75x75 cm verleiht als Bodenbelag der Umgebung den nordischen Charme des Light Livings. Dieser Stil erweckt im Badbereich bei den Gästen das Gefühl, sich in der eigenen Comfort Zone zu befinden.

La atmósfera de estilo «light living» con encanto nórdico, estilo en el que se inspira la zona de baño, se remata con el formato de 75x75 cm del suelo para suscitar la sensación de encontrarse en la zona de confort personal.

Напольные плиты формата 75x75 см, дополняют полную очарования обстановку, выдержанную в северо-европейском стиле, ставшем источником вдохновения дизайна ванной комнаты. Его цель - создать у гостей ощущение комфорта.



COURT
PORCELAIN TILES

Aix Fumée
120x120 cm | 47 1/4" x 47 1/4" ± 20 mm

LIVING
PORCELAIN TILES

Aix Fumée Matte
120x120 cm | 47 1/4" x 47 1/4"

BATHROOM
WALL TILES

Aix Cendre Matte
40x80 cm | 15 3/4" x 31 1/2"

Aix 3D Row Cendre Matte
40x80 cm | 15 3/4" x 31 1/2"

Aix Cendre Corner Matte
1,4x40 cm | 5/8" x 15 3/4"

Aix 3D Cendre Corner Matte
1,4x40 cm | 5/8" x 15 3/4"

PORCELAIN TILES

Aix Cendre Matte
75x75 cm | 29 1/2" x 29 1/2"

Aix Cendre Matte
75x150 cm | 29 1/2" x 59"

AIX

Porcelain tiles

COLOURED BODY PORCELAIN TILES - RECTIFIED MONOCALIBER

GRES PORCELLANATO COLORATO IN MASSA - RETTIFICATO MONOCALIBRO

Grès cérame coloré dans la masse - Rectifié mono-calibre / Durchgefärbtes Feinsteinzeug - Geschliffen einkalibrig

Gres porcelánico coloreado en masa - Rectificado monocolor / Керамический гранит окрашенный в массе - Ретифицированный в одном калибре

Sizes and surfaces / Formati e superfici

MATTE / MATT / MAT / MATT / MATE / MATOBAЯ

120x120 cm - 47¹/₄"x47¹/₄" ± 9 mm

75x150 cm - 29¹/₂"x59" ± 9 mm

75x75 cm - 29¹/₂"x29¹/₂" ± 9 mm

37,5x75 cm - 14³/₄"x29¹/₂" ± 9 mm

Sizes available in all colors / Formati disponibili in tutti i colori



GRIP / GRIP

37,5x75 cm - 14³/₄"x29¹/₂" ± 9 mm

Size available in all colors / Formato disponibile in tutti i colori



TEXTURED / STRUTTURATO / TEXTURISÉ

STRUKTURIERT / ESTRUCTURADO / СТРУКТУРИРОВАННЫЙ

NOT RECTIFIED / NON RETTIFICATO / NON RECTIFIÉ /

NICHT REKTIFIZIERT / NO RECTIFICADA / НЕРЕТИФИЦИРОВАННЫЕ

22,5x45,3 cm - 8⁷/₈"x17³/₄" ± 9 mm

22,5x22,5 cm - 8⁷/₈"x8⁷/₈" ± 9 mm

> Beige, Cendre



OUTDOOR PAVING ±20 mm / PAVIMENTI DA ESTERNO ±20 mm

REVÊTEMENTS DE SOL EXTÉRIEURS ±20 mm / BÖDEN IM AUSSENBEREICH ±20 mm

PAVIMENTOS EXTERNOS ±20 mm / НАРУЖНЫЕ НАПОЛЬНЫЕ ПОКРЫТИЯ ±20 mm

120x120 cm - 47¹/₄"x47¹/₄" ± 20 mm

60x90 cm - 23⁵/₈"x35³/₈" ± 20 mm

Sizes available in all colors / Formati disponibili in tutti i colori



60x60 cm - 23⁵/₈"x23⁵/₈" ± 20 mm

> Beige, Cendre

NOT RECTIFIED / NON RETTIFICATO / NON RECTIFIÉ /

NICHT REKTIFIZIERT / NO RECTIFICADA / НЕРЕТИФИЦИРОВАННЫЕ

22,5x45,4 cm - 8⁷/₈"x17³/₄" ± 20 mm

22,5x22,5 cm - 8⁷/₈"x8⁷/₈" ± 20 mm

> Beige, Cendre

Porcelain tiles ± 20 mm

For further details on the 20mm thick products, related trim pieces and installation systems - in particular for recommendations and precautions during installation- please refer to the Outdoor Design section on the Atlas Concorde website or to the Outdoor Design catalogue. / Per dettagli sul prodotto e sui relativi pezzi speciali in 20mm di spessore, per i sistemi di posa e, in particolare, per raccomandazioni, accorgimenti e precauzioni in fase di posa e progettazione, si raccomanda di prendere visione del catalogo Outdoor Design e della sezione Outdoor Design del sito Atlas Concorde.

Color-shading / Stonalizzazione

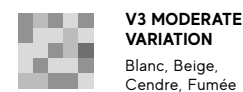

V3 MODERATE VARIATION
Blanc, Beige,
Cendre, Fumée

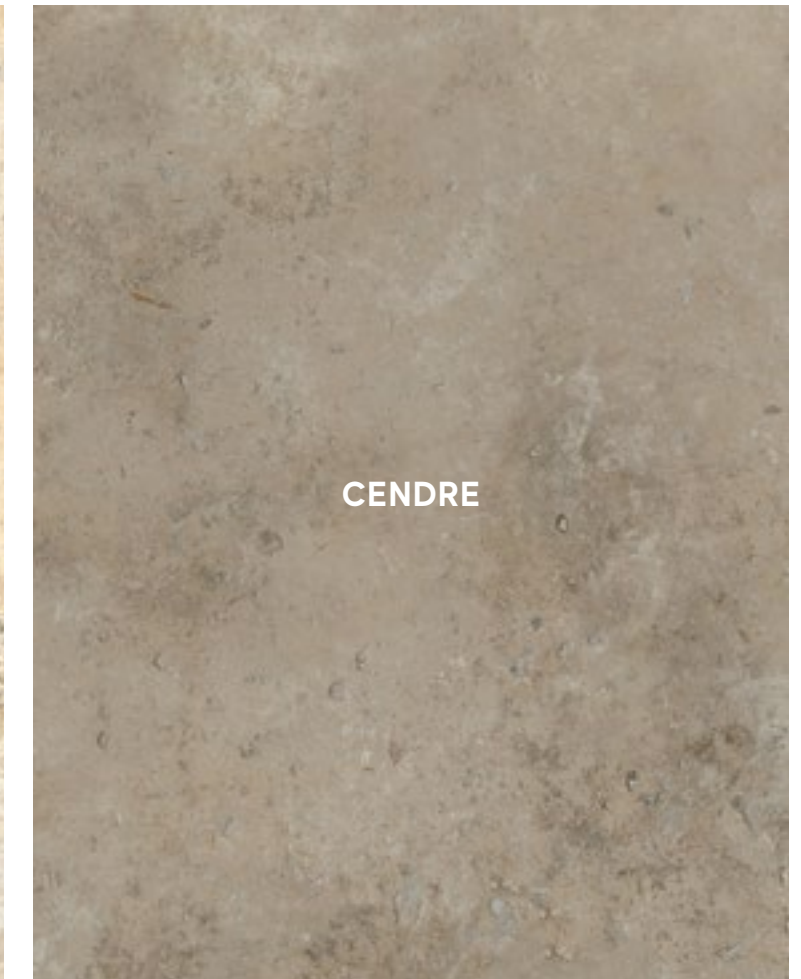

AIX

Porcelain tile decors

Aix Blanc



Kit Multiformato Tumbled*
 1 pcs 75x75 cm - 29¹/₂"x29¹/₂"
 1 pcs 50x75 cm - 19⁵/₈"x29¹/₂"
 1 pcs 50x50 cm - 19⁵/₈"x19⁵/₈"
 3 pcs 25x50 cm - 9⁷/₈"x19⁵/₈"
 2 pcs 25x25 cm - 9⁷/₈"x9⁷/₈"

Aix Beige



Kit Multiformato Tumbled*
 1 pcs 75x75 cm - 29¹/₂"x29¹/₂"
 1 pcs 50x75 cm - 19⁵/₈"x29¹/₂"
 1 pcs 50x50 cm - 19⁵/₈"x19⁵/₈"
 3 pcs 25x50 cm - 9⁷/₈"x19⁵/₈"
 2 pcs 25x25 cm - 9⁷/₈"x9⁷/₈"

Aix Cendre



Kit Multiformato Tumbled*
 1 pcs 75x75 cm - 29¹/₂"x29¹/₂"
 1 pcs 50x75 cm - 19⁵/₈"x29¹/₂"
 1 pcs 50x50 cm - 19⁵/₈"x19⁵/₈"
 3 pcs 25x50 cm - 9⁷/₈"x19⁵/₈"
 2 pcs 25x25 cm - 9⁷/₈"x9⁷/₈"

Aix Fumée



Kit Multiformato Tumbled*
 1 pcs 75x75 cm - 29¹/₂"x29¹/₂"
 1 pcs 50x75 cm - 19⁵/₈"x29¹/₂"
 1 pcs 50x50 cm - 19⁵/₈"x19⁵/₈"
 3 pcs 25x50 cm - 9⁷/₈"x19⁵/₈"
 2 pcs 25x25 cm - 9⁷/₈"x9⁷/₈"

* Tumbled / Burattato / Tamisé / Genarbt / Tamboreado / Выщербленный

NOTES / NOTE

The miniatures of the Kit Multiformato are not in proportion. | I minimali nel Kit Multiformato non sono in proporzione. | Les illustrations à échelle réduite dans le Kit Multiformato ne sont pas proportionnelles. | Die Abbildungen im Kit Multiformato sind nicht verhältnismäßig. | Los miniaturas en el Kit Multiformato no están en proporción. | Изображения Kit Multiformato не соблюдают пропорций.

One box is needed to create a complete Module. Each box contains: | Per comporre un Modulo intero occorre una scatola. Ogni scatola contiene: | Un carton est nécessaire pour composer un Module entier. Chaque carton contient : | Für ein vollständiges Modul benötigt man eine Karton. Jeder Karton enthält: | Para componer un módulo completo sirve una caja. Cada caja contiene: | Коробка необходима для составления одного модуля. Каждая коробка содержит:

Kit Multiformato Tumbled*
 1 pcs 75x75 cm - 29¹/₂"x29¹/₂"
 1 pcs 50x75 cm - 19⁵/₈"x29¹/₂"
 1 pcs 50x50 cm - 19⁵/₈"x19⁵/₈"
 3 pcs 25x50 cm - 9⁷/₈"x19⁵/₈"
 2 pcs 25x25 cm - 9⁷/₈"x9⁷/₈"



atlas concorde

AIX

Porcelain tile decors

Aix Blanc Honeycomb Tumbled*
30x31 cm - 11³/₄"x12¹/₄"



Aix Beige Honeycomb Tumbled*
30x31 cm - 11³/₄"x12¹/₄"



Aix Cendre Honeycomb Tumbled*
30x31 cm - 11³/₄"x12¹/₄"



Aix Fumée Honeycomb Tumbled*
30x31 cm - 11³/₄"x12¹/₄"

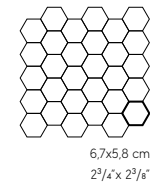

Aix Blanc Mosaico Tumbled*
30x30 cm - 11³/₄"x11³/₄"



Aix Beige Mosaico Tumbled*
30x30 cm - 11³/₄"x11³/₄"



Aix Cendre Mosaico Tumbled*
30x30 cm - 11³/₄"x11³/₄"



Aix Fumée Mosaico Tumbled*
30x30 cm - 11³/₄"x11³/₄"

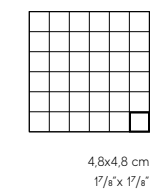

Aix Blanc Brick Tumbled*
37x37 cm - 14⁵/₈"x14⁵/₈"



Aix Beige Brick Tumbled*
37x37 cm - 14⁵/₈"x14⁵/₈"

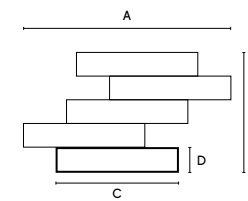

A: 62.7 cm
B: 36.7 cm
C: 36.65 cm
D: 7.15 cm

Aix Cendre Brick Tumbled*
37x37 cm - 14⁵/₈"x14⁵/₈"



Aix Fumée Brick Tumbled*
37x37 cm - 14⁵/₈"x14⁵/₈"



* Tumbled / Burattato / Tamisé / Genarbt / Tamboreado / Выщербленный



AIX

Wall tiles

WHITEBODY WALL TILES - RECTIFIED MONOCALIBER

RIVESTIMENTI IN PASTA BIANCA - RETTIFICATO MONOCALIBRO

Revêtements en pâte blanche - Rectifié mono-calibre / Weißscherbige Wandfliesen - Geschliffen einkalbrig

Revestimientos en pasta blanca - Rectificado monocolor / Настенная плитка из белой глины - Ретицированный в одном калибре

Sizes and surfaces / Formati e superfici

MATTE / MATT

40x80 cm - 15³/₄"x31¹/₂" ± 8,5 mm

Size available in all colors / Formato disponibile in tutti i colori

3D WALL TILES

40x80 cm - 15³/₄"x31¹/₂" ± 10 mm 3D Row

Size available in all colors / Formato disponibile in tutti i colori

Aix Blanc

40x80 cm - 15³/₄"x31¹/₂"



Aix 3D Row Blanc

40x80 cm - 15³/₄"x31¹/₂"



Aix Beige

40x80 cm - 15³/₄"x31¹/₂"

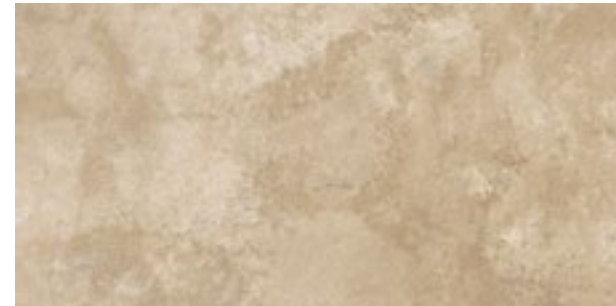

Aix 3D Row Beige

40x80 cm - 15³/₄"x31¹/₂"

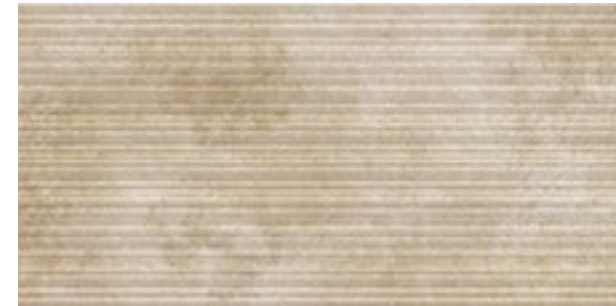

Aix Cendre

40x80 cm - 15³/₄"x31¹/₂"

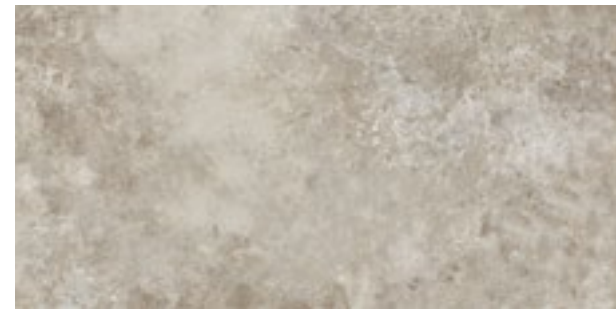

Aix 3D Row Cendre

40x80 cm - 15³/₄"x31¹/₂"



V2 SLIGHT VARIATION

Aix Blanc
Minibrick Tumbled*
30,5x30,5 cm - 12"x12"



Aix Beige
Minibrick Tumbled*
30,5x30,5 cm - 12"x12"



Aix Cendre
Minibrick Tumbled*
30,5x30,5 cm - 12"x12"

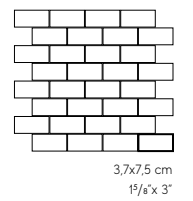

* Tumbled / Burattato / Tamisé / Genarbt / Tamboreado / Выщербленный



AIX

Porcelain tiles

INDOOR TILE PATTERNS / SCHEMI DI POSA INDOOR

SCHÉMAS DE POSE INTÉRIEURS / INDOOR-VERLEGEPLÄNE

ESQUEMA DE COLOCACIÓN EN INTERIORES / СХЕМЫ УКЛАДКИ ВНУТРИ ПОМЕЩЕНИЙ

SIZES - FORMATI

37,5x75 = 40%

75x75 = 60%

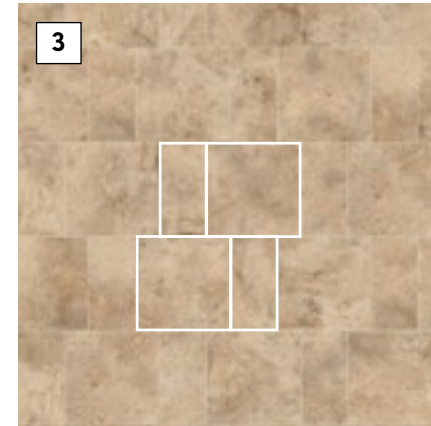
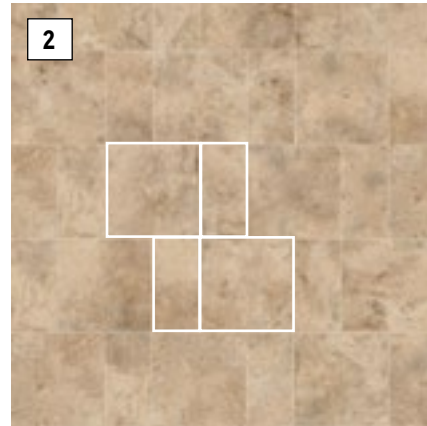
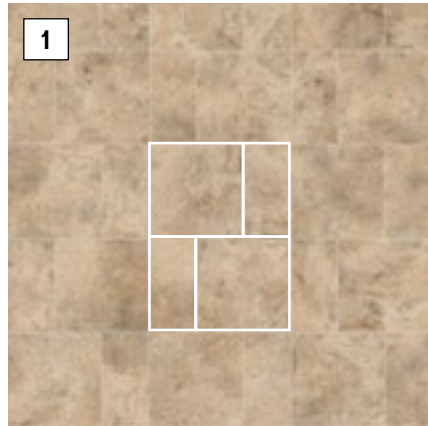

SIZES - FORMATI

37,5x75 = 14%

75x75 = 29%

75x150 = 57%

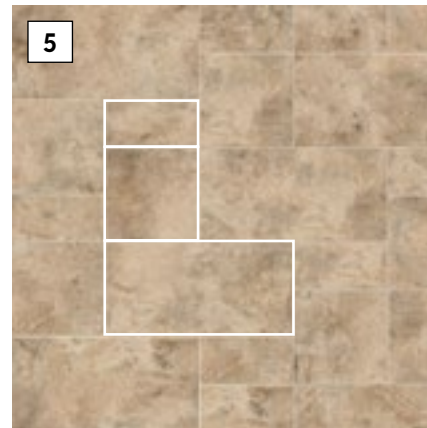
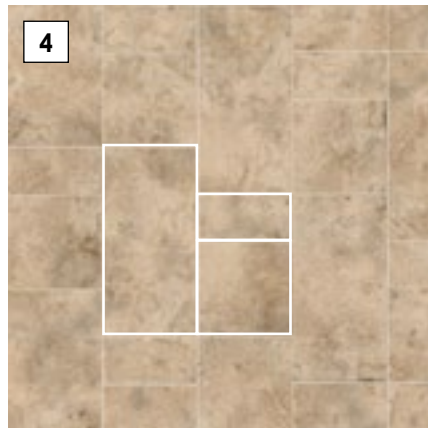

SIZES - FORMATI

37,5x75 = 57%

75x75 = 43%

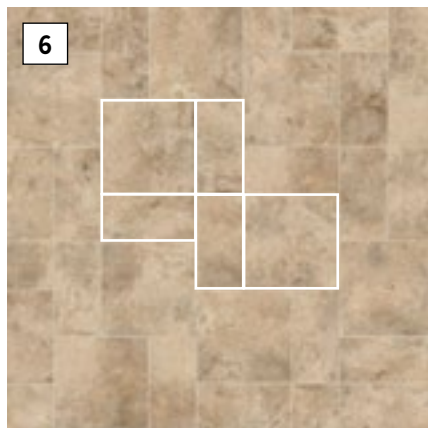

For rectified sizes, we suggest a 2mm grout line / Per i formati rettificati fuga consigliata 2 mm /
Pour les formats rectifiés, il est conseillé d'utiliser un joint de 2mm / Für geschliffene Formate wird eine
Fugenbreite von 2 mm empfohlen / Con los formatos rectificadas se aconseja una junta de 2 mm /
При использовании ректифицированных плит рекомендуется оставлять швы толщиной 2 мм.



AIX

Porcelain tiles

OUTDOOR TILE PATTERNS / SCHEMI DI POSA OUTDOOR
SCHÉMAS DE POSE EXTÉRIEURS / OUTDOOR-VERLEGEPLÄNE
ESQUEMA DE COLOCACIÓN EN EXTERIORES / СХЕМЫ УКЛАДКИ НА УЛИЦЕ

SIZES - FORMATI
22,5x22,5 = 100%

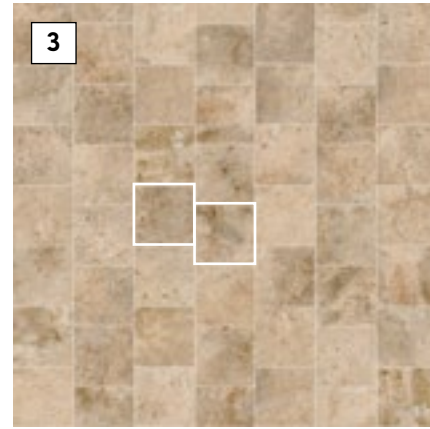
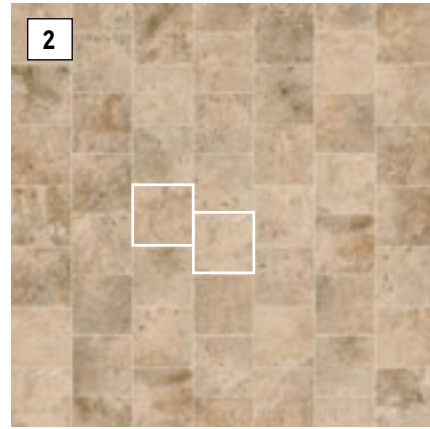
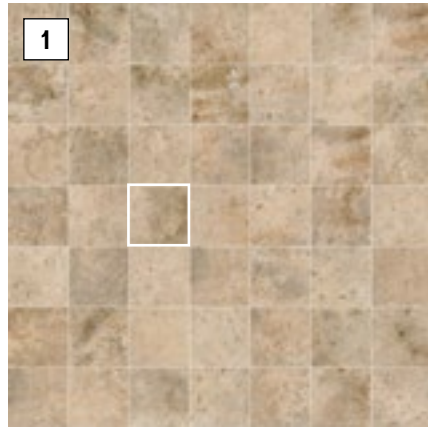

SIZES - FORMATI
22,5x45 = 100%

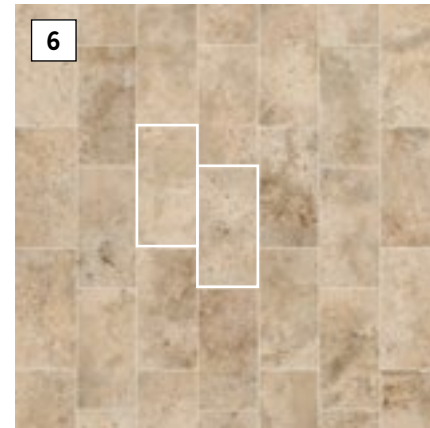
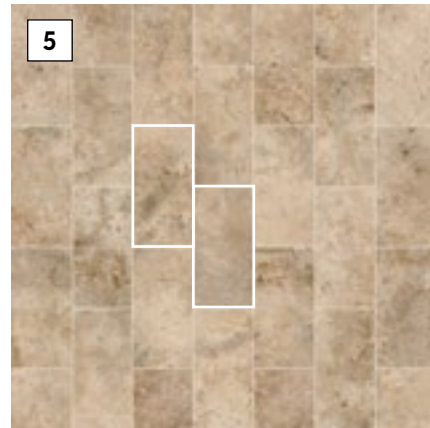

SIZES - FORMATI
22,5x45 = 100%

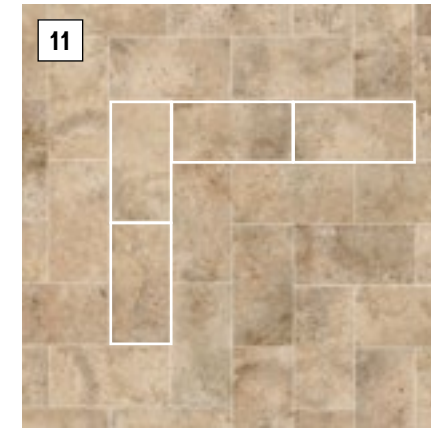
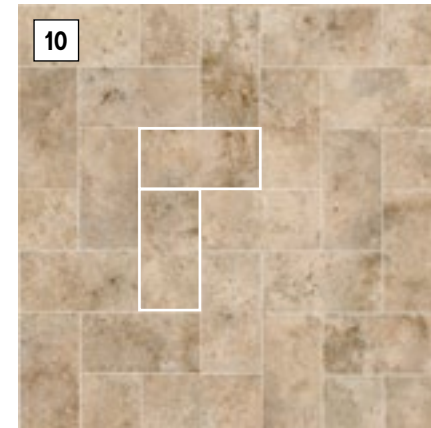
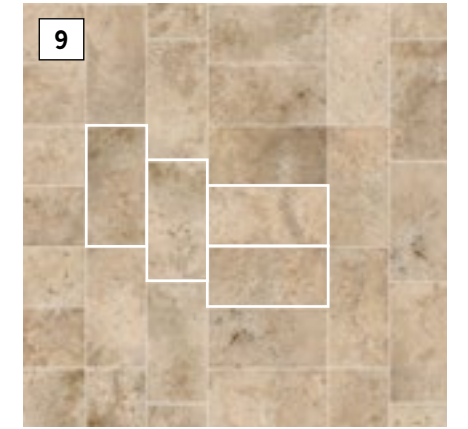
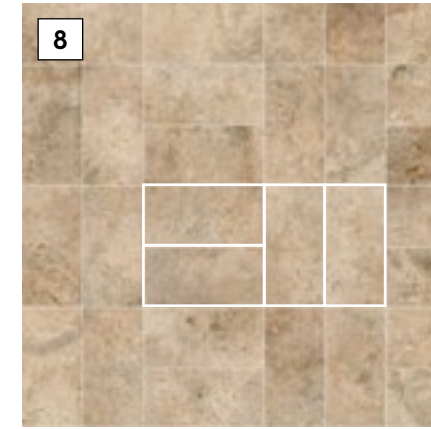
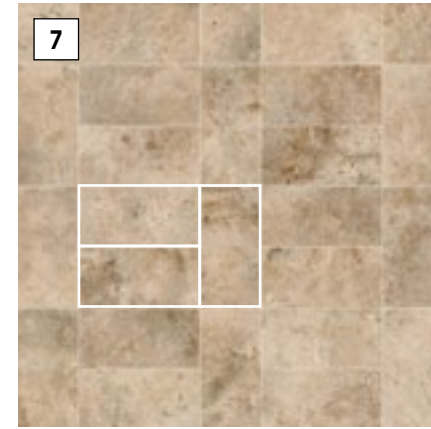

AIX

Porcelain tiles

OUTDOOR TILE PATTERNS / SCHEMI DI POSA OUTDOOR
SCHÉMAS DE POSE EXTÉRIEURS / OUTDOOR-VERLEGEPLÄNE
ESQUEMA DE COLOCACIÓN EN EXTERIORES / СХЕМЫ УКЛАДКИ НА УЛИЦЕ

SIZES - FORMATI

22,5x22,5 = 50%

22,5x45 = 50%

SIZES - FORMATI

22,5x22,5 = 33%

22,5x45 = 67%

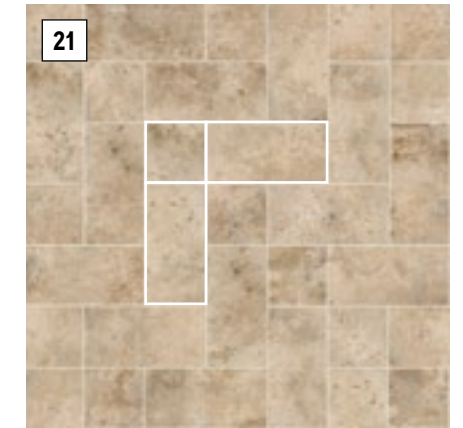
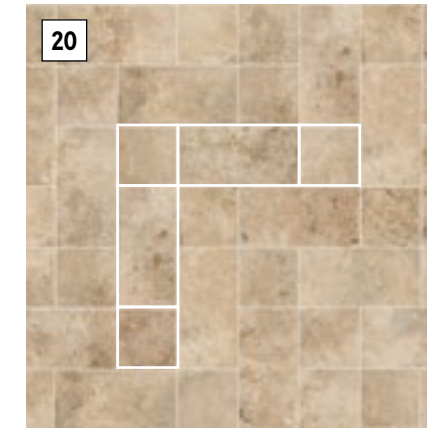
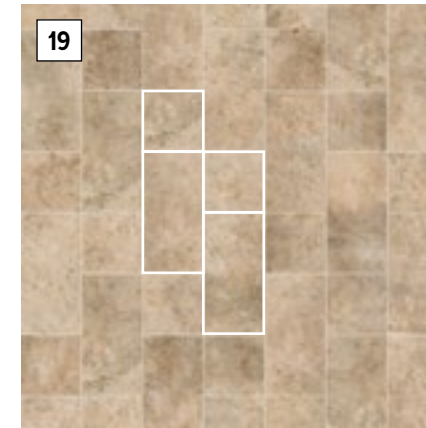
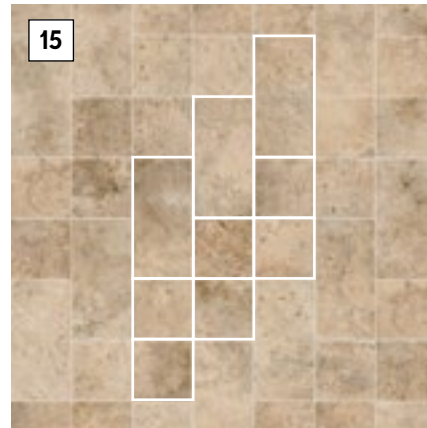
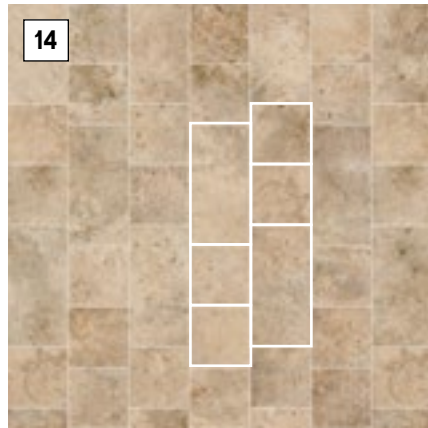
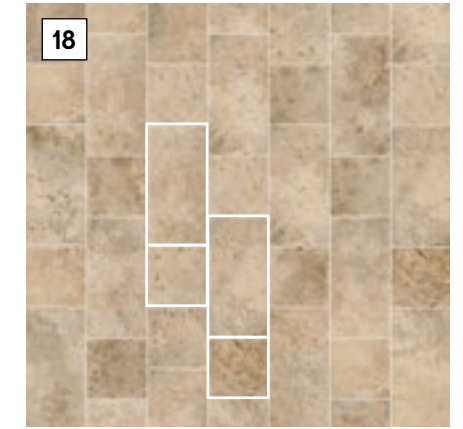
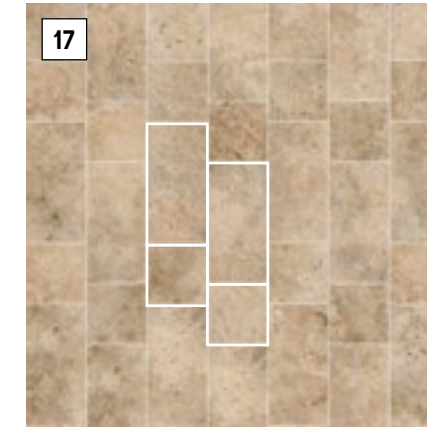
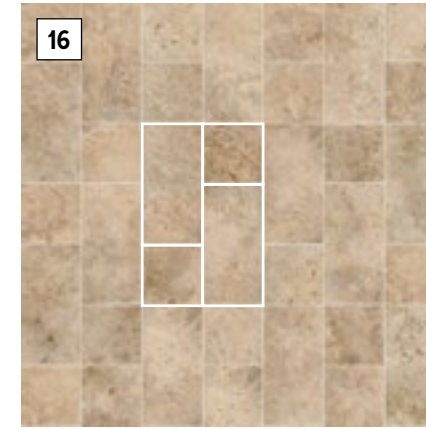
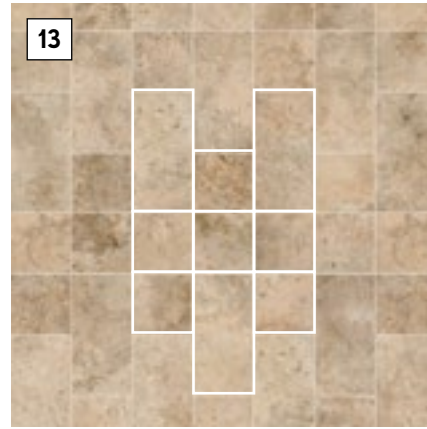
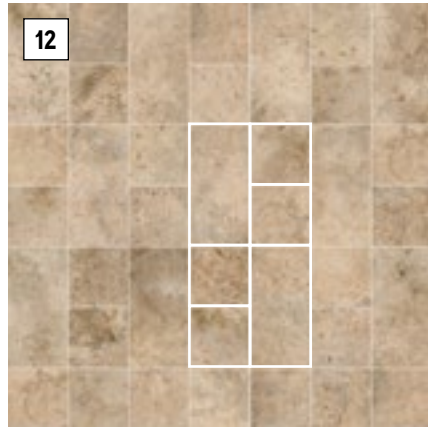

22,5x22,5 = 60%
22,5x45 = 40%

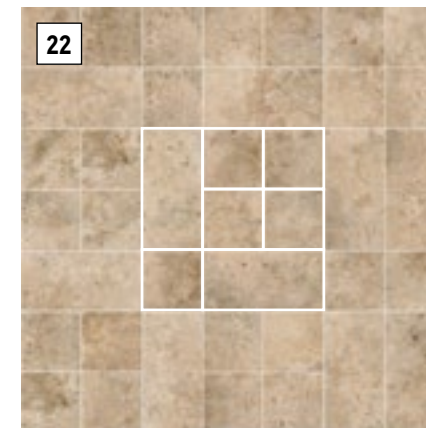

22,5x22,5 = 11%
22,5x45 = 89%

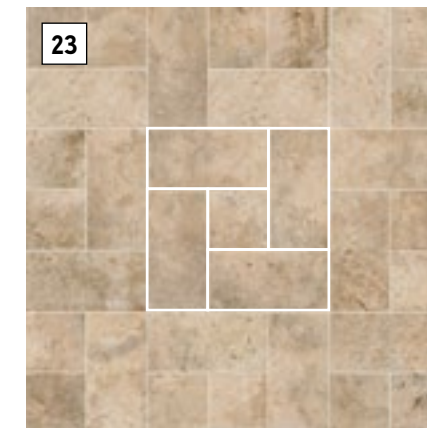

22,5x22,5 = 50%
22,5x45 = 50%

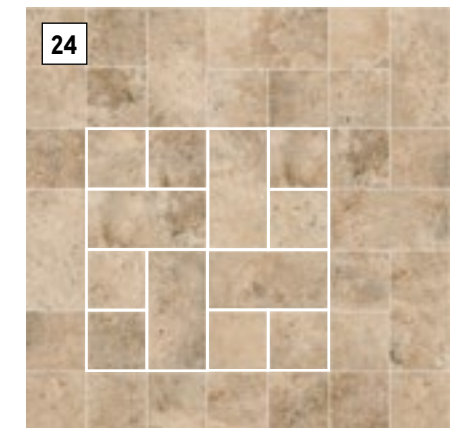

AIX

Porcelain trim tiles

INDOOR TRIM TILES

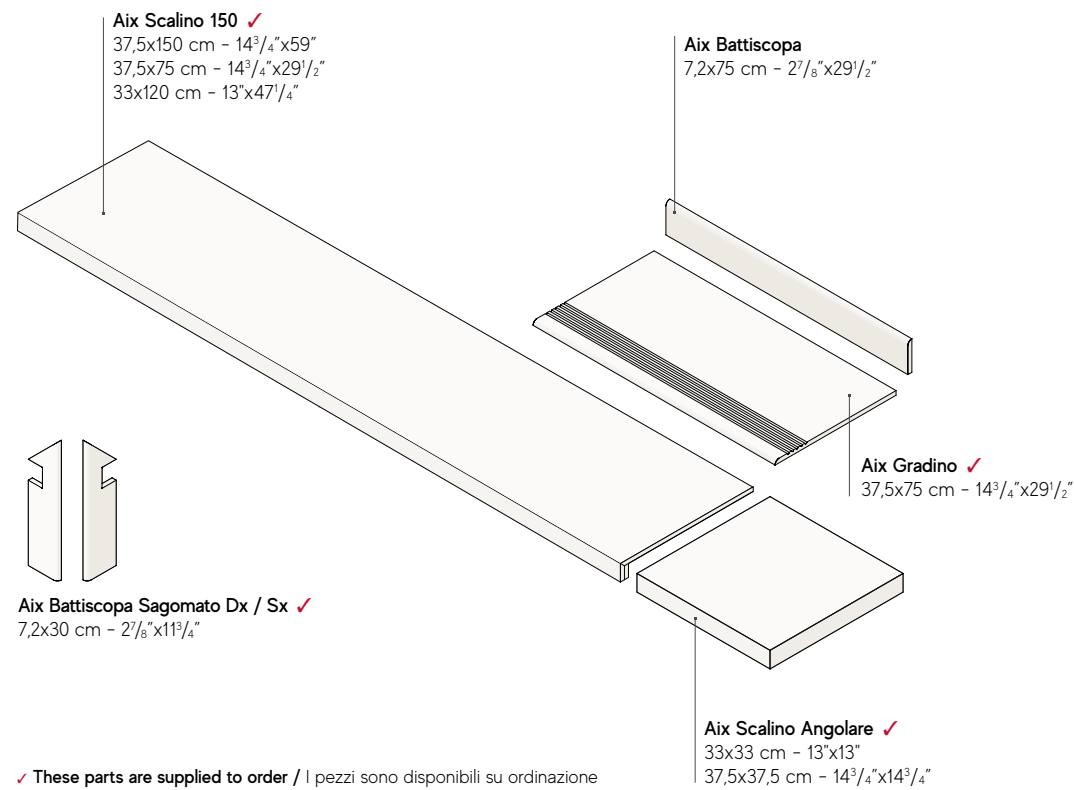

OUTDOOR TRIM TILES



OUTDOOR TRIM TILES ± 20 mm

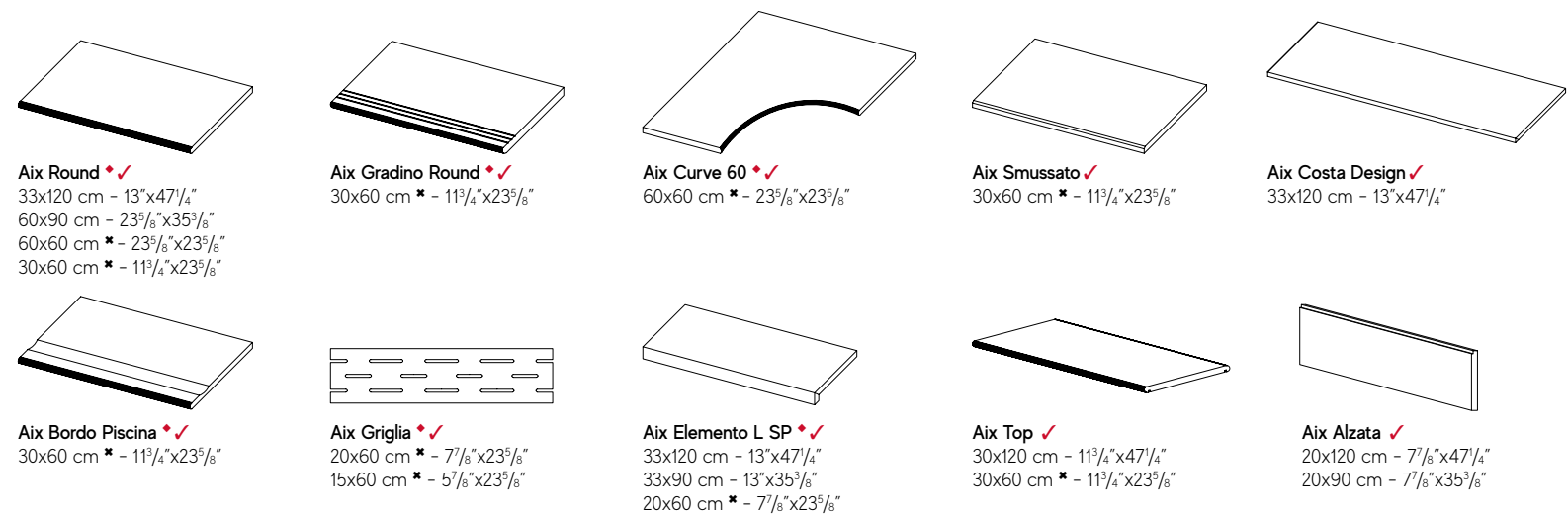

♦ Right/left angular elements are available / Sono disponibili gli elementi angolari dx/sx
 * Available in the following colors: / Disponibile nei seguenti colori: **Beige, Cendre**
 ✓ These parts are supplied to order / I pezzi sono disponibili su ordinazione

WALL TRIM TILES

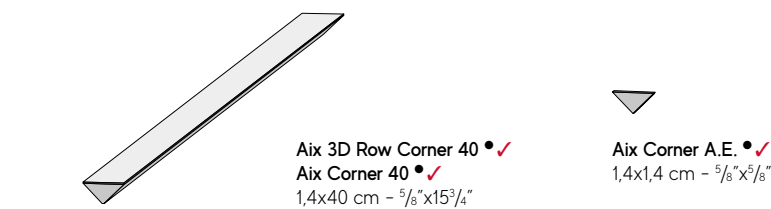

NOTES / NOTE

For information and details relating to codes, packaging and weight it is recommended to refer to the latest pricelist. | Per le informazioni e i dati relativi a codici, imballaggi e pesi occorre sempre consultare l'ultimo listino aggiornato e in vigore. | Pour toutes informations et renseignements concernant les codes, les emballages et les poids, il y a toujours lieu de consulter le dernier tarif en vigueur et mis à jour. | Für Informationen und Daten die den Code, die Verpackung und das Gewicht betreffen bitte die aktuellste Preisliste zugrunde legen. | Para acceder a la información y a los datos relativos a códigos, embalajes y pesos hay que consultar siempre la última lista de precios actualizada y vigente. | Для информации о кодах, упаковках и весе обращайтесь к последнему действующему прайс-листу.

Colors and optical features of the materials illustrated in this catalogue are to be regarded as mere indications. | I colori e le caratteristiche estetiche dei materiali illustrati nel presente catalogo sono da ritenersi puramente indicativi. | Les coloris et les caractéristiques esthétiques des références illustrées dans le catalogue sont donnés à titre purement indicatif. | Die Farben und die ästhetischen Eigenschaften der in diesem Katalog abgebildeten Produkte sind als reine Richtwerte zu betrachten. | Los colores y las características estéticas de los materiales ilustrados en el presente catálogo deben ser considerados como puramente indicativos. | Цвета и эстетические характеристики описанных в настоящем каталоге материалов являются только ориентировочными.

Atlas Concorde reserves the right to modify any product without notice and will not be liable for any direct or indirect damage resulting from such modifications. | Atlas Concorde si riserva di modificare i prodotti senza preavviso, declinando ogni responsabilità su eventuali danni diretti o indiretti derivanti da eventuali modifiche. | Atlas Concorde se réserve le droit de modifier ses produits sans préavis et décline toute responsabilité concernant les éventuels dommages directs ou indirects qui pourraient dériver de ces modifications. | Atlas Concorde behält sich das Recht vor jederzeit und ohne vorherige Ankündigung, die Produkte zu verändern, und lehnt jede Haftung bei direkten oder indirekten Schäden ab, die von diesen Veränderungen herrühren. | Atlas Concorde se reserva el derecho de modificar los productos sin previo aviso, rechaza cualquier responsabilidad sobre eventuales daños directos o indirectos derivados de eventuales modificaciones. | Atlas Concorde оставляет за собой право изменять характеристики изделий без предварительного уведомления, отклоняя при этом любую ответственность за прямые или косвенные убытки, возникшие в результате изменений.

CERAMIC AND PORCELAIN TILES: A SAFE CHOICE

Resistance and duration

RESISTENZA E DURATA

Easy to maintain ✎
Facile da mantenere



Porcelain tiles do not require any special maintenance.

Il gres porcellanato non richiede manutenzioni particolari.

UV Resistant ✎
Resistente ai raggi UV

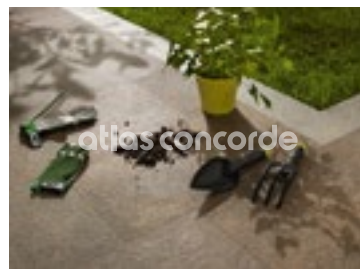

Porcelain tiles maintain their colors even when exposed to continuous, direct sunlight or in contact with atmospheric agents or smog.

Il gres porcellanato rimane inalterato nei suoi colori anche se esposto alla luce diretta e continua del sole o a contatto con agenti atmosferici o smog.

Scratch resistant ✎
Resistente al graffio

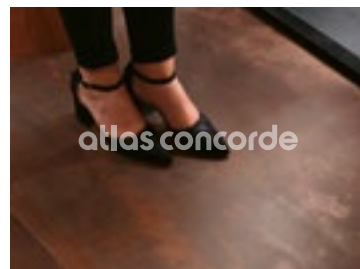

Porcelain tiles do not splinter, break or get damaged.

Il gres porcellanato non si scheggia, non si rompe e non si danneggia.

Easy to clean ✎
Facile da pulire



Porcelain tiles are easy to clean.

Il gres porcellanato si pulisce facilmente.

Waterproof ✎
Resistente all'acqua

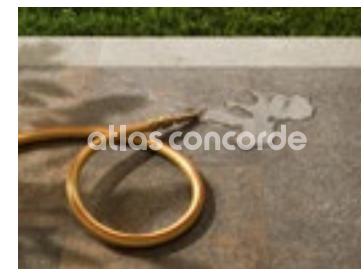

Porcelain tiles are completely non-porous and therefore are not damaged by water or humidity.

Il gres porcellanato è completamente non poroso e non teme l'acqua e l'umidità.

Stain resistant ✎
Resistente alle macchie

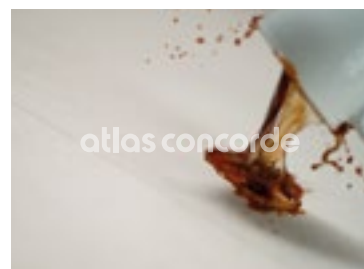

Porcelain tiles are waterproof, no liquid can damage the surface.

Il gres porcellanato è impermeabile e nessun tipo di liquido può danneggiarne la superficie.

Resistant to chemicals ✎
Resistente agli agenti chimici



Porcelain tiles do not stain and resist the most aggressive chemical agents.

Il gres porcellanato non si macchia e resiste agli agenti chimici più aggressivi.

Resistant to acids ✎
Resistente agli acidi



Porcelain tiles are resistant to acids found in food and cleaning products.

Il gres porcellanato resiste agli acidi di uso alimentare e domestico.

Resistant to thermal shock ✎
Resistente agli shock termici

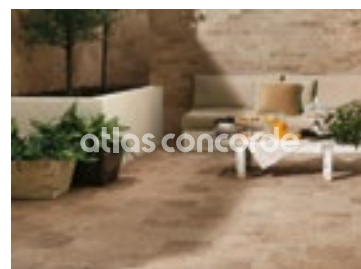

A porcelain tile floor will not change as a result of sharp temperature fluctuations.

Un pavimento in gres porcellanato non si altera a causa di sbalzi termici.

Health

SALUTE

Zero VOCs ✎
Zero VOC



Porcelain tiles are intrinsically inorganic and do not emit volatile organic compounds (VOC).

Le piastrelle in gres porcellanato sono intrinsecamente inorganiche e non emettono composti organici volatili.

Zero PVC ✎
Zero PVC



Porcelain tiles contain no PVC, plastics or petroleum derivatives.

Il gres porcellanato è privo di PVC, plastiche o derivati del petrolio.

Zero formaldehyde ✎
Zero formaldeide

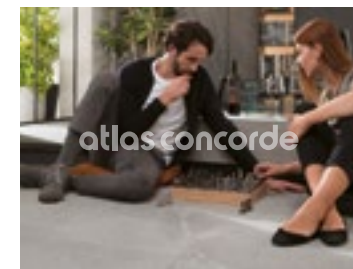

Porcelain tiles do not contain formaldehyde.

Il gres porcellanato non contiene formaldeide.

Frost resistant ✎
Resistente al ghiaccio



Porcelain tiles are frost resistant and therefore are not damaged by low temperatures.

Il gres porcellanato è ingelivo e resiste alle temperature più basse.

Zero allergens ✎
Zero allergeni



Porcelain tiles are inhospitable for mites, bacteria, fungi, molds, and other irritants.

Il gres porcellanato è inospitale per acari, batteri, funghi, muffe e altre sostanze irritanti.

Prevent bacterial growth ✎
Previene la crescita batterica



Porcelain tiles are completely hygienic and inhospitable for bacteria, mites, molds, and fungi.

Il gres porcellanato è assolutamente igienico e inospitale per i batteri, acari, muffe e funghi.

SAFETY

SICUREZZA

Non-slip

Antiscivolo



Porcelain tile surfaces can be made with an abrasive surface grit that can increase traction and reduce the risk of slipping.

Le superfici in gres porcellanato possono essere realizzate con una graniglia abrasiva superficiale in grado di aumentare la trazione e ridurre i rischi di scivolamento.

Fire resistant

Resistente al fuoco



Porcelain tiles are not flammable, reduce the spread of flames, do not burn, and do not emit toxic fumes.

Le piastrelle in gres porcellanato non sono infiammabili, riducono la propagazione della fiamma, non bruciano e non emettono fumi tossici.

Heat resistant

Resistente al calore

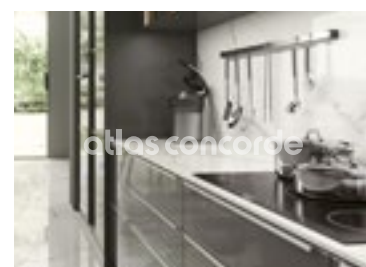

Porcelain tiles do not change shape at high temperatures.

Il gres porcellanato non si altera alle alte temperature.

ENVIRONMENT

AMBIENTE

Energy efficiency

Efficienza energetica



The high thermal inertia of porcelain tiles moderates the changes in temperature of the rooms, favoring energy savings.

L'elevata inerzia termica del gres porcellanato modera gli sbalzi di temperatura degli ambienti, favorendo il risparmio energetico.

Ecological

Ecologico



Porcelain tiles have a low environmental impact at all stages of their production, from the raw materials to disposal and recycling.

Il gres porcellanato ha un basso impatto ambientale in tutte le fasi del suo processo industriale, dalle materie prime fino allo smaltimento e al riciclo.

Recycling and re-use

Riciclo e riutilizzo



Porcelain tiles are made with recycled materials, last a long time, and can be re-used because they retain their original appearance.

Il gres porcellanato è realizzato con materiali di riciclo, dura a lungo e mantenendo l'aspetto originario può essere riciclato.

Ideal for floor heating systems

Ideale per sistemi di riscaldamento a pavimento



Porcelain tiles can be effectively combined with floor heating systems.

Il gres porcellanato può essere abbinato in modo efficace a sistemi di riscaldamento a pavimento.

WALL TILES ADDITIONAL BENEFITS

PROPRIETÀ CERAMICA
DA RIVESTIMENTO

Ease of installation

Facilità di lavorazione

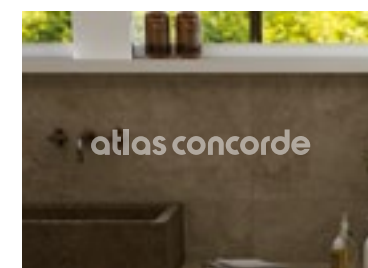

Cuts, holes, and bevels are easily made and reduce the time it takes to lay the white body tiles.

Tagli, fori, bisellature sono facili da realizzare e rendono più veloce la posa dei rivestimenti in pasta bianca.

Extremely easy to clean

Estrema facilità di pulizia



White body ceramic tiles can be cleaned with a simple passage of hot water or neutral detergent.

I rivestimenti ceramici in pasta bianca si puliscono con un semplice passaggio di acqua calda o detergente neutro.

While porcelain tiles are ideal for use on the floor thanks to their hardness and extreme durability, the light weight and workability of white body tiles make them ideal for use on walls: cuts and holes can be made quickly and easily, reducing installation time and costs.

Mentre il gres porcellanato è ideale per l'uso a pavimento, per la sua durezza e l'estrema resistenza, le caratteristiche di leggerezza e lavorabilità del rivestimento in pasta bianca lo rendono ideale per l'uso a parete: i tagli e i fori saranno eseguiti facilmente e velocemente, riducendo i tempi e i costi di posa.



LE GRÈS CÉRAME : LE CHOIX SÛR / DAS FEINSTEINZEUG: EINE SICHERE WAHL / GRES PORCELÁNICO: LA ELECCIÓN SEGURA / КЕРАМИКА: НАДЕЖНЫЙ ВЫБОР

Résistance et longévité

Résistance et longévité / Widerstandsfähigkeit und lebensdauer / Resistencia y durabilidad / Стойкость и долговечность

Entretien facile

Entretien facile / Leicht zu warten / Fácil de mantener / Простота ухода

Le grès cérame n'exige aucun entretien particulier. / Feinsteinzeug erfordert keine besonderen Wartungsarbeiten. / El gres porcelánico no requiere particulares operaciones de mantenimiento. / Керамогранит не нуждается в особом уходе.

Résistant aux rayons UV

Résistant aux rayons UV / UV-Strahlenfest / Resistente a los rayos UV / Стойкость к УФ-излучению

Les coloris du grès cérame restent inaltérés même s'il est exposé à la lumière directe et continue du soleil ou au contact du smog et des agents atmosphériques. / Die Farben des Feinsteinzeugs bleiben unverändert erhalten, auch wenn es direktem und ständigem Sonnenlicht, der Witterung oder Smog ausgesetzt ist. / El gres porcelánico no se altera con el paso del tiempo, tampoco cambia su color cuando está expuesto a la luz directa y continua del sol o cuando entra en contacto con agentes climatológicos o contaminación. / Керамогранит не выцветает даже при постоянном воздействии солнечного света, атмосферных факторов, смога.

Résistant aux rayures

Résistant aux rayures / Kratzfestigkeit / Resistente a las rayas / Стойкость к царапинам

Le grès cérame ne subit ni ébréchures, ni cassures, ni dommages. / Feinsteinzeug splittert nicht, es zerbricht nicht und erleidet keine Beschädigungen. / El gres porcelánico no se desportilla, no se rompe y no se estropea. / Керамогранит не раскалывается, не ломается, не повреждается.

Facile à nettoyer

Facile à nettoyer / Leicht zu reinigen / De fácil limpieza / Легкость чистки

Le grès cérame se nettoie facilement. / Feinsteinzeug kann leicht gereinigt werden. / El gres porcelánico se limpia fácilmente. / Керамогранит легко очищается.

Résistant aux taches

Résistant aux taches / Fleckenfestigkeit / Resistente a las manchas / Стойкость к пятнам

Le grès cérame est imperméable et aucun type de liquide ne peut endommager sa surface. / Feinsteinzeug ist wasserundurchlässig und Flüssigkeiten jeglicher Art können seine Oberfläche nicht beschädigen. / El gres porcelánico es impermeable y ningún tipo de liquido puede estropear la superficie. / Керамогранит непроницаем, и никакая жидкость не может повредить его поверхность.

Résistant aux agents chimiques

Résistant aux agents chimiques / Beständigkeit gegen chemikalien / Resistente a los agentes químicos / Стойкость к химическим веществам

Le grès cérame ne se tache pas et résiste aux agents chimiques les plus agressifs. / Feinsteinzeug ist fleckenfest und beständig gegen die aggressvsten Chemikalien. / El gres porcelánico no se mancha y es resistente a los agentes químicos más agresivos. / Даже самые агрессивные химикаты не повреждают керамогранит и не оставляют на нем пятен.

Résistant aux acides

Résistant aux acides / Beständigkeit gegen säuren / Resistente a los ácidos / Стойкость к кислотам

Le grès cérame résiste aux acides d'usage alimentaire et domestique. / Feinsteinzeug ist beständig gegen Säuren, die in Nahrungsmitteln oder im Haushalt verwendet werden. / El gres porcelánico es resistente a los ácidos de uso alimenticio y doméstico. / Керамогранит устойчив к кислотам, входящим в состав пищевых продуктов и средств бытовой химии.

Résistant aux écarts thermiques

Résistant aux écarts thermiques / Beständigkeit gegen thermoschocks / Resistente a los choques térmicos / Стойкость к перепадам температур

Un sol en grès cérame ne subit aucune altération suite aux écarts thermiques. / Ein Feinsteinzeug-Fußboden wird von Temperaturschwankungen nicht beeinträchtigt. / El pavimento de gres porcelánico no cambia a causa de cambios bruscos de temperatura. / Напольные покрытия из керамогранита не разрушаются при перепадах температуры.

Résistant à l'eau

Résistant à l'eau / Wasserfestigkeit / Resistente al agua / Стойкость к воде

Résistant au gel

Le grès cérame est absolument non poreux et ne craint ni l'eau ni l'humidité. / Feinsteinzeug ist absolut porös und fürchtet weder Wasser noch Feuchtigkeit. / El gres porcelánico no es poroso, no le penetra el agua y es resistente a la humedad. / Керамогранит – абсолютно непористый материал, поэтому не боится воды и влаги.

Résistant au gel

Résistant au gel / Frostbeständigkeit / Resistente a las heladas / Стойкость к морозам

Le grès cérame est ingélif et résiste aux températures les plus basses. / Feinsteinzeug ist frostbeständig und widersteht den niedrigsten Temperaturen. / El gres porcelánico es resistente a las heladas y a las bajas temperaturas. / Керамогранит способен противостоять морозам и низким температурам.

Santé

Santé

Santé

Santé

Santé

Santé

Santé

Santé

Santé

Santé

Santé

Santé

Santé

Santé

Santé

Santé

Santé

Santé

Santé

Santé

Santé

Santé

Santé

Santé

Santé

Santé

Santé

Santé

Santé

Santé

Santé

Santé

Santé

Santé

Santé

Santé

Santé

Santé

Santé

Santé

Santé

Santé

Zéro PVC / Null PVC / Cero PVC / Ноль ПВХ

Zéro PVC

Le grès cérame est privé de PVC, de matières plastiques et de dérivés du pétrole. / Feinsteinzeug ist frei von PVC, Kunststoffen oder Petroleumderivaten. / El gres porcelánico no contiene PVC, plástico o sustancias que derivan del petróleo. / Керамогранит не содержит ПВХ, пластиковых материалов, нефтепродуктов.

Zéro PVC

Zéro PVC

Zéro PVC

Zéro PVC

Zéro PVC

Zéro PVC

Zéro PVC

Zéro PVC

Zéro PVC

Zéro PVC

Zéro PVC

Zéro PVC

Zéro PVC

Zéro PVC

Zéro PVC

Zéro PVC

Zéro PVC

Zéro PVC

Zéro PVC

Zéro PVC

Zéro PVC

Zéro PVC

Zéro PVC

Zéro PVC

Zéro PVC

Zéro PVC

Zéro PVC

Zéro PVC

Zéro PVC

Zéro PVC

Zéro PVC

Zéro PVC

Zéro PVC

Zéro PVC

Zéro PVC

Zéro PVC

Zéro PVC

Zéro PVC

Zéro PVC

Zéro PVC

Zéro PVC

Zéro PVC

Zéro PVC

Zéro PVC

Zéro PVC

Zéro PVC

Zéro PVC

Zéro PVC

Zéro PVC

Zéro PVC

Zéro PVC

Zéro PVC

Zéro PVC

Zéro PVC

Zéro PVC

Zéro PVC

Zéro PVC

Zéro PVC

Zéro PVC

Zéro PVC

Environnement / Umwelt / Ambiente / Окружающая среда

Environnement

Environnement

Environnement

Environnement

Environnement

Environnement

Environnement

Environnement

Environnement

Environnement

Environnement

Environnement

Environnement

Environnement

Environnement

Environnement

Environnement

Environnement

Environnement

Environnement

Environnement

Environnement

Environnement

Environnement

Environnement

Environnement

Environnement

Environnement

Environnement

Environnement

Environnement

Environnement

Environnement

Environnement

Environnement

Environnement

Environnement

Environnement

Environnement

Environnement

Environnement

Environnement

Environnement

Environnement

Environnement

Environnement

Environnement

Environnement

Environnement

Environnement

Environnement

Environnement

Environnement

Environnement

Environnement

Environnement

Environnement

Environnement

Environnement

Environnement

Environnement

Environnement

Environnement

Environnement

Environnement

PROPRIÉTÉS DE LA CÉRAMIQUE POUR REVÊTEMENTS / EIGENSCHAFTEN DER WANDFLIESEN / CARACTERÍSTICAS Y BENEFICIOS DE LA CERÁMICA PARA REVESTIMIENTO / СВОЙСТВА КЕРАМИЧЕСКОЙ ПЛИТКИ

Tandis que le grès cérame est idéal pour l'usage au sol en raison de sa dureté et de son extrême résistance, les caractéristiques de légèreté et d'usinabilité des carreaux en pâte blanche en font l'idéal pour l'usage mural : les découpes et les perçages s'effectuent facilement et rapidement, en réduisant les temps et les coûts de la pose. / Während das Feinsteinzeug dank seiner Härte und extremen Widerstandsfähigkeit ideal für die Fußbodenverlegung ist, machen die Leichtheit und die Verarbeitungsfreundlichkeit der weißscherbigen Wandbeläge diese ideal für Wandverlegungen: Schnitte und Bohrungen werden leicht und schnell ausgeführt, wodurch die Verlegungszeiten und -kosten sich verringern. / Si bien el gres porcelánico es indicado para su uso en pavimentos, por su dureza y máxima resistencia, el revestimiento de pasta blanca es indicado para su uso en paredes por sus propiedades de ligereza y facilidad de trabajo: se consigue una mejor facilidad y rapidez de cortes y perforación, reduciendo los tiempos y costes de colocación. / Если керамогранит, в силу своей твердости и стойкости, особенно рекомендован для полов, то такие характеристики, как небольшой вес и высокая обрабатываемость, делают плитку из белой глины идеальной для монтажа на стену: легкость и быстрота резки и сверления снижают затраты времени и денег на укладку.

Facile à travailler

Facile à travailler

Facile à travailler

Facile à travailler

Facile à travailler

Facile à travailler

Facile à travailler

Facile à travailler

Facile à travailler

Facile à travailler

Facile à travailler

Facile à travailler

Facile à travailler

Facile à travailler

Facile à travailler

Facile à travailler

Facile à travailler

Facile à travailler

Facile à travailler

Facile à travailler

Facile à travailler

Facile à travailler

Facile à travailler

Facile à travailler

Facile à travailler

Facile à travailler

Facile à travailler

Facile à travailler

Facile à travailler

Facile à travailler

Facile à travailler

Facile à travailler

Facile à travailler

Facile à travailler

Facile à travailler

Facile à travailler

Facile à travailler

Facile à travailler

Facile à travailler

Facile à travailler

Facile à travailler

INDEX



White-body wall tiles - Rectified monocaliber

Compliant with standards EN 14411 annex L group B11
Compliant with standards ISO 13006 annex L group B11
Conforme alla norma EN 14411 Appendice L gruppo B11
Conforme alla norma ISO 13006 Appendice L gruppo B11

Rivestimenti in pasta bianca - Rettificato monocalibro

40x80 cm - 15³/₄"x31¹/₂" ± 8,5 mm
40x80 cm - 15³/₄"x31¹/₂" ± 10 mm 3D Row

Technical features Caratteristiche tecniche	Test Method Metodo di prova	Requirements for nominal size N Requisiti per dimensione nominale N		
		7 cm ≤ N < 15 cm		N ≥ 15 cm
		(mm)	(%)	(mm)
Length and width Lunghezza e larghezza	ISO 10545-2	± 0,75 (*)	± 0,5 (*)	± 2,0 (*)
Thickness Spessore		± 0,5 (**)	± 10 (***)	± 0,5 (**)
Straightness of sides Rettilineità degli spigoli		± 0,5 (****)	± 0,3 (****)	± 1,5 (****)
Rectangularity Ortogonalità		± 0,75 (****)	± 0,5 (****)	± 2,0 (****)
Surface flatness Planarità	ISO 10545-2	c.c. + 0,75 - 0,50	c.c. + 0,5 - 0,3	c.c. + 2,0 - 1,5
		e.c. + 0,75 - 0,50	e.c. + 0,5 - 0,3	e.c. + 2,0 - 1,5
		w. ± 0,75	w. ± 0,5	w. ± 2,0
Water absorption (in % by mass) Massa d'acqua assorbita (come % della massa)	ISO 10545-3	Average >10%. When the average > 20%, this shall be indicated. Individual value > 9% Media >10%. Se questo valore > 20%, deve essere indicato. Valore Singolo > 9%		
Breaking strength Sforzo di rottura	ISO 10545-4	S ≥ 600 N		
Modulus of rupture Resistenza alla flessione		R ≥ 15 N/mm ²		
Coefficient of thermal linear expansion Coefficiente di dilatazione termica lineare	ISO 10545-8	Declared value Valore dichiarato		
Thermal shock resistance Resistenza agli sbalzi termici	ISO 10545-9	Pass according to EN ISO 10545-1 Test superato in accordo con ISO 10545-1		
Moisture expansion (in mm/m) Dilatazione all'umidità (in mm/m)	ISO 10545-10	Declared value Valore dichiarato		
Crazing resistance Resistenza al cavillo	ISO 10545-11	Pass according to EN ISO 10545-1 Test superato in accordo con ISO 10545-1		
Bond strength/adhesion for improved cementitious adhesives Adesione a trazione con adesivi cementizi migliorati	EN 1348	Declared value Valore dichiarato		
Reaction to fire Reazione al fuoco	-	Class A1 Classe A1		
Resistance to household chemicals and swimming pool salts Resistenza ai prodotti chimici di uso domestico ed agli additivi per piscina	ISO 10545-13	Minimum Class B (GB for glazed tiles) Classe minima B (GB per piastrelle smaltate)		
		Declared Class Classe dichiarata		
		Declared Class Classe dichiarata		
Resistance to staining Resistenza alle macchie	ISO 10545-14	Minimum Class 3 Classe 3 minima		
Release of dangerous substances: Cadmium (in mg/dm²) and Lead (in mg/dm²) Rilascio di sostanze pericolose: Cadmio (in mg/dm²) e Piombo (in mg/dm²)	ISO 10545-15	Declared value Valore dichiarato		

(*) The permissible deviation, in % or mm, of the average size for each tile (2 or 4 sides) from work size (WS). Deviazione ammissibile, in % oppure mm, della dimensione media di ogni piastrella (2 oppure 4 lati) dalla dimensione di fabbricazione (WS).
(**) The permissible deviation, in % or mm, of the average thickness for each tile from the work size thickness (WS). Deviazione ammissibile, in % oppure mm, dello spessore medio di ogni piastrella dallo spessore riportato nella dimensione di fabbricazione (WS).
(***) The maximum permissible deviation from straightness, in % or mm, related to the corresponding work sizes (WS). Deviazione massima ammissibile di rettilineità, in % oppure mm, in rapporto alle dimensioni di fabbricazione (WS) corrispondenti.
(****) The maximum permissible deviation from rectangularity, in % or mm, related to the corresponding work sizes (WS). Deviazione massima ammissibile di ortogonalità, in % oppure mm, in rapporto alle dimensioni di fabbricazione (WS) corrispondenti.
c.c. The maximum permissible deviation from centre curvature, in % or mm, related to diagonal calculated from the work sizes (WS). Deviazione massima ammissibile della curvatura del centro, in % oppure mm, in rapporto alla diagonale calcolata secondo le dimensioni di fabbricazione (WS).
e.c. The maximum permissible deviation from edge curvature, in % or mm, related to the corresponding work sizes (WS). Deviazione massima ammissibile della curvatura dello spigolo, in % oppure mm, in rapporto alle dimensioni di fabbricazione (WS) corrispondenti.
w. The maximum permissible deviation from warpage, in % or mm, related to diagonal calculated from the work sizes (WS). Deviazione massima ammissibile dello svergolamento, in % oppure mm, in rapporto alla diagonale calcolata secondo le dimensioni di fabbricazione (WS).

Wall tiles

± 0,3% ± 1,0 mm	3D Not applicable Non applicabile
± 10,0% ± 0,5 mm	
± 0,3% ± 0,8 mm	
± 0,3% ± 1,5 mm	
± 0,3% ± 1,5 mm	
10% < E _v ≤ 20 %	
S ≥ 600 N	
R ≥ 15 N/mm ²	
≤ 7MK ⁻¹	
Resistant Resiste	
≤ 0,06% (0,6mm/m)	
Resistant Resiste	
≥ 1,0 N/mm ² (Class C2 - EN 12004)	
A1	
A	
LA	
HA	
5	
≤ 0,01 mg/dm ² Cd ≤ 0,1 mg/dm ² Pb	

Coloured body porcelain tiles - Rectified monocaliber



Compliant with standards EN 14411 annex G group B1a
Compliant with standards ISO 13006 annex G group B1a
Conforme alla norma EN 14411 Appendice G gruppo B1a
Conforme alla norma ISO 13006 Appendice G gruppo B1a

Gres porcellanato colorato in massa - Rettificato monocalibro

120x120 cm - 47¹/₈"x47¹/₈" ± 9 mm
75x150 cm - 29¹/₂"x59" ± 9 mm
75x75 cm - 29¹/₂"x29¹/₂" ± 9 mm
37,5x75 cm - 14³/₈"x29¹/₂" ± 9 mm
120x120 cm - 47¹/₈"x47¹/₈" ± 20 mm
60x90 cm - 23³/₈"x35³/₈" ± 20 mm
60x60 cm - 23³/₈"x23³/₈" ± 20 mm
22,5x45,3 cm - 8⁷/₈"x17³/₈" ± 9 mm
22,5x22,5 cm - 8⁷/₈"x8⁷/₈" ± 9 mm
22,5x45,4 cm - 8⁷/₈"x17³/₈" ± 20 mm
22,5x22,5 cm - 8⁷/₈"x8⁷/₈" ± 20 mm

■ Not rectified / Non rettificato

Technical features Caratteristiche tecniche	Test Method Metodo di prova	Requirements for nominal size N / Requisiti per dimensione nominale N		
		7 cm ≤ N < 15 cm		N ≥ 15 cm
		(mm)	(%)	(mm)
Length and width Lunghezza e larghezza	ISO 10545-2	± 0,9 (*)	± 0,6 (*)	± 2,0 (*)
		Thickness Spessore	± 0,5 (**)	± 5 (***)
Straightness of sides Rettilineità degli spigoli		± 0,75 (****)	± 0,5 (****)	± 1,5 (****)
Rectangularity (Measurement only on short edges when L/1 ≥ 3) Ortogonalità (Misurazione da condurre solo sui lati corti quando L/1 ≥ 3)		± 0,75 (****)	± 0,5 (****)	± 2,0 (****)
Surface flatness Planarità	ISO 10545-2	c.c. ± 0,75	c.c. ± 0,5	c.c. ± 2,0
		e.c. ± 0,75	e.c. ± 0,5	e.c. ± 2,0
		w. ± 0,75	w. ± 0,5	w. ± 2,0
Water absorption (in % by mass) Massa d'acqua assorbita (come % della massa)	ISO 10545-3 ASTM C 373-18	E _v ≤ 0,5% Individual Maximum 0,6% E _v ≤ 0,5% Valore massimo singolo 0,6% Requirement ANSI A137.1-2017 Water absorption max ≤ 0,5%		
Breaking strength Sforzo di rottura	ISO 10545-4	S ≥ 700N (for thickness < 7,5 mm - per spessore < 7,5 mm) S ≥ 1300N (for thickness ≥ 7,5 mm - per spessore ≥ 7,5 mm)		
Modulus of rupture Resistenza alla flessione		R ≥ 35 N/mm ²		
Bending strength and breaking load Resistenza a flessione e al carico di rottura (4)(5)	EN 1339 Annex F	-		
Impact resistance, as coefficient of restitution Resistenza all'impatto, espresso come coefficiente di restituzione	ISO 10545-5	Declared value Valore dichiarato		
Mohs hardness Durezza Mohs	EN 101	-		
Resistance to deep abrasion of unglazed tiles (removed volume) Resistenza all'abrasione profonda delle piastrelle non smaltate (volume materiale asportato)	ISO 10545-6	≤ 175 mm ³		
Coefficient of thermal linear expansion Coefficiente di dilatazione termica lineare	ISO 10545-8	Declared value Valore dichiarato		
Thermal shock resistance Resistenza agli sbalzi termici	ISO 10545-9	Pass according to EN ISO 10545-1 Test superato in accordo con ISO 10545-1		
Moisture expansion (in mm/m) Dilatazione all'umidità (in mm/m)	ISO 10545-10	Declared value Valore dichiarato		
Frost resistance Resistenza al gelo	ISO 10545-12	Pass according to EN ISO 10545-1 Test superato in accordo con ISO 10545-1		
Bond strength/adhesion for improved cementitious adhesives Adesione a trazione con adesivi cementizi migliorati	EN 1348	Declared value Valore dichiarato		
Reaction to fire Reazione al fuoco	-	Class A1 or A1 _s Classe A1 oppure A1 _s		
Resistance to household chemicals and swimming pool salts Resistenza ai prodotti chimici di uso domestico e agli additivi per piscina	ISO 10545-13	Minimum Class B Classe minima B		
		Declared Class Classe dichiarata		
		Declared Class Classe dichiarata		
Resistance to staining for unglazed tiles Resistenza alle macchie per piastrelle non smaltate	ISO 10545-14	Declared Class Classe dichiarata		
Shod Ramp Test Metodo della rampa "calzato"	DIN 51130	Declared value Valore dichiarato		
	Barefoot Ramp Test Metodo della rampa a piedi nudi	DIN 51097	Declared value Valore dichiarato	
Pendulum Friction Test Metodo del Pendolo	BS 7976	PTV ≥ 36 classifies the surface as "low slip risk"		
	AS 4586	Declared Classification of the new pedestrian surface materials according to the Pendulum Test		
	UNE-ENV 12633	Declared value Valore dichiarato		
Coefficient of friction (COF) Coefficiente di attrito	B.C.R.A. Rep. CEC/81	D. M. 236/89 del 14/06/89 μ > 0,40 per elemento scivolante cuoio su pavimentazione asciutta μ > 0,40 per elemento scivolante gomma dura su pavimentazione bagnata		
Dynamic coefficient of friction (DCOF) Coefficiente di attrito dinamico	ANSI A137.1	ANSI A.137.1-2017 Requires a minimum value of 0.42 for level interior space expected to be walked upon when wet. (3)		

(*) The permissible deviation, in % or mm, of the average size for each tile (2 or 4 sides) from work size (WS). Deviazione ammissibile, in % oppure mm, della dimensione media di ogni piastrella (2 oppure 4 lati) dalla dimensione di fabbricazione (WS).
(**) The permissible deviation, in % or mm, of the average thickness for each tile from the work size thickness (WS). Deviazione ammissibile, in % oppure mm, dello spessore medio di ogni piastrella dallo spessore riportato nella dimensione di fabbricazione (WS).
(***) The maximum permissible deviation from straightness, in % or mm, related to the corresponding work sizes (WS). Deviazione massima ammissibile di rettilineità, in % oppure mm, in rapporto alle dimensioni di fabbricazione (WS) corrispondenti.
(****) The maximum permissible deviation from rectangularity, in % or mm, related to the corresponding work sizes (WS). Deviazione massima ammissibile di ortogonalità, in % oppure mm, in rapporto alle dimensioni di fabbricazione (WS) corrispondenti.
c.c. The maximum permissible deviation from centre curvature, in % or mm, related to diagonal calculated from the work sizes (WS). Deviazione massima ammissibile della curvatura del centro, in % oppure mm, in rapporto alla diagonale calcolata secondo le dimensioni di fabbricazione (WS).
e.c. The maximum permissible deviation from edge curvature, in % or mm, related to the corresponding work sizes (WS). Deviazione massima ammissibile della curvatura dello spigolo, in % oppure mm, in rapporto alle dimensioni di fabbricazione (WS) corrispondenti.
w. The maximum permissible deviation from warpage, in % or mm, related to diagonal calculated from the work sizes (WS). Deviazione massima ammissibile dello svergolamento, in % oppure mm, in rapporto alla diagonale calcolata secondo le dimensioni di fabbricazione (WS).
(1) Determination of slip resistance of pedestrian surfaces; it does not cover sports surfaces and road surfaces for vehicles (skid resistance). Determinazione della resistenza allo scivolamento delle superfici pedonali; non si applica alle pavimentazioni sportive ed alle pavimentazioni stradali veicolari.
(2) Anti-slip performance is guaranteed at the time of delivery of the product. Le prestazioni anti-slip vengono garantite al momento della consegna del prodotto.
(3) However, tiles with a DCOF of 0.42 or greater are not necessarily suitable for all projects. The specifier shall determine tiles appropriate for specific project conditions, considering by way of example, but not in limitation, type of use, traffic, expected contaminants, expected maintenance, expected wear, and manufacturers' guidelines and recommendations.
(4) For further details, please refer to outdoor design general catalogue. Per maggiori informazioni riferirsi al catalogo generale Outdoor Design.
(5) Only for products with 20 mm thickness. Solo per prodotti a 20mm di spessore.
(*) If not rectified: "Suitable for". Se non rettificato: "Conforme".

Green Project

Sustainability / Sostenibilità

In the environmental and economic sciences, sustainability is defined as the condition of development capable of ensuring the satisfaction of the needs of the present generation without compromising the ability of future generations to realize their own. Several international certifications guarantee that the Atlas Concorde products meet the criteria of sustainable construction, attesting to their low impact on the ecosystem, compliance with declared standards and attention to comfort.

Nelle scienze ambientali ed economiche, la sostenibilità è definita come condizione di uno sviluppo in grado di assicurare il soddisfacimento dei bisogni della generazione presente senza compromettere la possibilità delle generazioni future di realizzare i propri. Diverse certificazioni internazionali garantiscono che i prodotti Atlas Concorde rispondono ai criteri del costruire sostenibile, attestandone il basso impatto sull'ecosistema, la conformità agli standard dichiarati e l'attenzione al comfort abitativo.

Certifications / Certificazioni



ISO 9001

In 1995 Atlas Concorde obtained ISO 9001 quality certification for its products. It is an international recognition referring to the company's entire quality system, from the receipt of raw materials to their transformation, from the distribution of the product to their placement on the market.

Sin dal 1995 Atlas Concorde ha ottenuto per i propri prodotti la certificazione di qualità ISO 9001. Si tratta di un riconoscimento internazionale riferito all'intero sistema di qualità aziendale, dall'ingresso delle materie prime alla loro trasformazione, dalla distribuzione del prodotto alla sua immissione sul mercato.

LEED V4*

All Atlas Concorde porcelain floor and white body wall tiles can be used in projects that follow the guidelines of the GREEN BUILDING COUNCIL, which promotes the independent certification system LEED BD&C v4 (Leadership in Energy and Environmental Design, Building Design & Construction), whose parameters establish precise criteria for the design and construction of buildings that are healthy, energy efficient and with low environmental impact. All our products in porcelain stoneware and in white clay can therefore contribute to obtaining the LEED V4 rating of buildings, in relation to different areas: Sustainable Sites, Materials and Resources, Internal Environmental Quality.

Tutti i prodotti in gres porcellanato e in pasta bianca Atlas Concorde possono essere utilizzati in progetti che seguono le linee guida del GREEN BUILDING COUNCIL, che promuove il sistema di certificazione indipendente LEED BD&C v4 (Leadership in Energy and Environmental Design, Building Design & Construction), i cui parametri stabiliscono precisi criteri di progettazione e realizzazione di edifici salubri, energeticamente efficienti e a impatto ambientale contenuto. Tutti i nostri prodotti in gres porcellanato e in pasta bianca possono quindi contribuire all'ottenimento del rating LEED V4 degli edifici, relativamente a diverse aree tematiche: Siti Sostenibili, Materiali e Risorse, Qualità ambientale Interna.

EPD

Atlas Concorde also has an EPD declaration, which attests to the environmental sustainability of its products. The EPD (Environmental Product Declaration) also assesses the life cycle of a product, from extraction to production, transport, installation, maintenance, and cleaning. Atlas Concorde's EPD declaration was certified by the independent certifying body EPD ITALY.

Atlas Concorde dispone inoltre di una dichiarazione EPD, che attesta la sostenibilità ambientale dei prodotti. Anche la EPD (Environmental Product Declaration) valuta il ciclo di vita di un prodotto, dall'estrazione all'utilizzo passando per la produzione, il trasporto, l'installazione, la manutenzione e la pulizia. La dichiarazione EPD di Atlas Concorde è stata certificata dall'ente di certificazione indipendente EPD ITALY.

PEF*

The environmental footprint of products (PEF, Product Environmental Footprint, according to Recommendation 2013/179/EU) is a measurement that, based on various criteria, indicates the environmental performance of a product or service over its lifetime, taking into account supply chain activities: from the extraction of raw materials, to the production, use, and end of life of the product. Atlas Concorde has a verified PEF. Atlas Concorde's PEF was verified by the DNV-GL certifying body.

L'impronta ambientale dei prodotti (PEF, Product Environmental Footprint, secondo la Raccomandazione 2013/179/UE) è una misura che, sulla base di vari criteri, indica le prestazioni ambientali di un prodotto o servizio nel corso del proprio ciclo di vita, tenendo conto delle attività della catena di approvvigionamento: dall'estrazione di materie prime, alla produzione, all'uso e fine vita del prodotto. Atlas Concorde dispone di una PEF verificata. La PEF di Atlas Concorde è verificata dall'organismo di certificazione DNV-GL.

FDES*

Atlas Concorde has also drafted an FDES environmental declaration (Fiche de déclaration environnementale et sanitaire), this also having the purpose of transparently disclosing the product's impact, covering each phase from product extraction to production and finally laying and use.

Atlas Concorde ha realizzato inoltre la dichiarazione ambientale FDES (Fiche de déclaration environnementale et sanitaire), anch'essa con lo scopo di rendicontare in modo trasparente l'impatto del prodotto, a partire dalla fase di estrazione del prodotto, passando dalla fase di produzione, fino alla posa ed all'utilizzo.

HPD

Atlas Concorde has a HPD (Health Product Declaration) declaration, a complete report on the health characteristics of the finished product, compiled according to the HPD standard.

Atlas Concorde dispone della dichiarazione HPD (Health Product Declaration), un report completo sulle caratteristiche di salubrità del prodotto finito, compilato secondo lo standard HPD.

CAM/ISO 14021

An environmental declaration according to the ISO 14021 international standard, observance of Minimum Environmental Criteria, and the adoption of sustainability policies demonstrate Atlas Concorde's attention to environmental issues and allow the inclusion of its products in Green Public Tenders.

La dichiarazione ambientale secondo lo standard internazionale ISO 14021 ed il rispetto dei requisiti dei Criteri Ambientali Minimi permette ad Atlas Concorde, grazie all'adozione di politiche di sostenibilità, di dimostrare l'attenzione alle problematiche ambientali e proporre l'inserimento dei propri prodotti negli Appalti Pubblici Verdi.

For further details, please refer to / Per ulteriori dettagli, fare riferimento a: atlasconcorde.com



MADE IN ITALY. MADE TO EXCEL.

MADE IN ITALY

The Made in Italy logo of Atlas Concorde stands for style, quality and ethics. Having firmly adhered to the Ethical Code promoted by Confindustria Ceramica, Atlas Concorde places the Made in Italy logo on all the products designed and produced in Italy, that is to say ceramic tiles, decorations and the majority of special trim tiles. Only a small amount of the latter is manufactured in Spain. Atlas Concorde products are produced using eco-friendly technologies, top quality and safe raw materials with the best working conditions guaranteed for our personnel. For these reasons, Atlas Concorde's Made in Italy is the expression of strong values such as style, design, product quality, and respect for the environment and the people who live in it.

Il marchio Made in Italy di Atlas Concorde è sinonimo di stile, qualità ed etica. Avendo aderito con convinzione al Codice Etico di Confindustria Ceramica, Atlas Concorde appone il marchio Made in Italy su tutti i prodotti studiati, progettati e realizzati in Italia, nella fattispecie tutte le piastrelle di ceramica, le decorazioni e la maggioranza dei pezzi speciali. Solo un ristretto numero di questi ultimi è fabbricato in Spagna. I prodotti Atlas Concorde sono inoltre realizzati con tecnologie rispettose dell'ambiente, utilizzando materie prime eccellenti e sicure, garantendo le migliori condizioni di lavoro. Per queste ragioni il Made in Italy di Atlas Concorde è espressione di valori forti quali stile, design, qualità del prodotto, attenzione all'ambiente e alle persone.



The Ceramics of Italy logo is an exclusive identification on ceramic products which have effectively been made in Italy by companies that are a part of the Confindustria Ceramica and who adhered to its Ethical Code. This Code, promoted and created by Confindustria Ceramica, commits all companies to communicate, clearly and with transparency, the origin of their products.

Il marchio Ceramics of Italy contrassegna esclusivamente i prodotti ceramici effettivamente realizzati in Italia da un'azienda associata a Confindustria Ceramica che ha sottoscritto il Codice Etico. Il Codice, redatto dalla stessa Confindustria Ceramica, impegna a comunicare con chiarezza l'origine dei prodotti.

www.ceramica.info

CERAMICHE ATLAS CONCORDE S.p.A.
Via Canaletto 141
41042 Spezzano di Fiorano (MO) - Italia

ATLAS CONCORDE USA, Inc.
117 Seaboard Lane - Suite 170
Franklin, TN 37067 - USA

ATLAS CONCORDE RUSSIA
Business centre "Meliora Place"
Prospekt Mira 6, 129090 Moscow - Russia

atlasconcorde.com



Copyright 2019 by Ceramiche Atlas Concorde S.p.A.
(Spezzano di Fiorano, MO - Italy)
September 2019