

STILUS WALL

3D-BIM



design by Giuseppe Bavuso



Allacciamento idraulico **verticale** con interasse 35 mm
Vertical hydraulic connection with distance between pipes 35 mm
 Connexion hydraulique **vertical** avec entraxe 35 mm
 Standardanschluss **seitlich** mit Achsabstand 35 mm
 Conexión hidráulica **vertical** con distancia entre centros de 35 mm.
Вертикальное гидравлическое соединение с расстоянием между трубами 35 мм

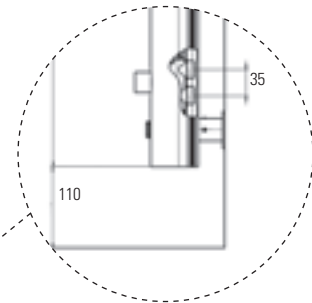

codice code code Artikel Nr. codigo код	altezza height hauteur Höhe altura высота	larghezza width largeur Breite ancho ширина	interasse distance between bars entraxe Achsabstand distancia entre centros межцентровое расстояние	output мощность 75/65-20 watt* Δt50
FSTIW1600...	1600	200	35	350

Watt = Kcal/h ÷ 0,860
 Kcal/h = Watt × 0,860

Materiale: Alluminio **Material: aluminium** **Matériel: aluminium** **Material: Aluminium** **Material: Aluminio** **Материал – алюминий**

- * I watt hanno valori provvisori in attesa di certificazione Δt50.
- * The watt values are not definitive awaiting for Δt50 certification.
- * Le nombre de Watts est une valeur indiquée à titre provisoire dans l'attente de la certification Δt50.
- * Die Wattwerte sind vorläufig bis zur Δt50 Zertifizierung.
- * Los Vativos tienen valores provisionales en espera de la certificación Δt50.
- * До получения сертификата Δt50 приводится предварительное значение мощности в ваттах.

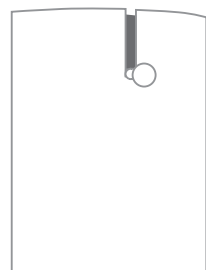

Appendiabito in acciaio inox satinato
 Satin stainless steel clothes hook
 Patère en acier inox satiné
 Kleiderhalter aus satiniertem Edelstahl
 Pomo colgador de acero inoxidable satinado
 Вешалка из сатирированной нержавеющей стали

STILUS WALL LED



A richiesta: Kit LED con scheda e due barre Led 24 volt + telecomando
On request: LED kit with circuit board and two LED lights 24 volt + remote control
Sur demande: Kit LED avec un circuit imprimé et deux lumières LED 24 volts + télécommande
Auf Anfrage: Kit LED mit Leiterplatte und zwei LED-Leuchten 24 Volt + Fernbedienung
Bajo pedido: Kit LED con placa de circuito y dos luces LED de 24 voltios + control remoto
По запросу: Комплект светодиодов с монтажной платой и двумя светодиодами 24 вольт + пультом

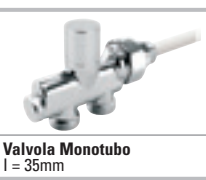

Valvola monotubo cromo satinata di serie
 Standard satin chrome single-pipe valve
 Vanne monotube chrome satinée de série
 Serienmäßiges Einrohrventil aus satiniertem Chrom
 Válvula monotubo cromo satinada de serie
 Клапан для 1-трубной системы матовый хром в стандартной комплектации

Valvola Monotubo
 l = 35mm

FINITURE SPECIALI . SPECIAL FINISHES . FINITIONS SPECIALES - OBERFLÄCHENFARBEN - ACABADOS ESPECIALES . СПЕЦИАЛЬНАЯ ОТДЕЛКА

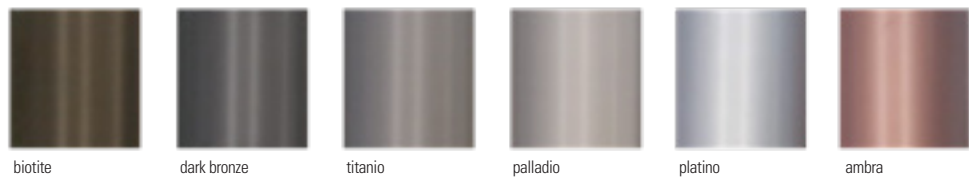

STILUS SINGLE ELEC LED



design by Giuseppe Bavuso

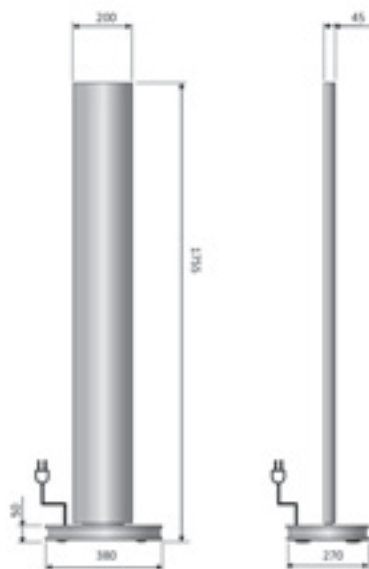

Calorifero con 250 watt di potenza, fornito con telecomando di serie per la regolazione delle luci LED e del termostato, programmazione giornaliera / settimanale

Radiator 250 watt power with standard remote control for regulation of the LED lights and thermostat, daily / weekly programming

Radiateur de 250 watt de puissance équipé d'une télécommande de série pour régler les lumières LED et le thermostat, programmation quotidienne / hebdomadaire

Heizkörper 250 Watt mit Fernbedienung zur Einstellung der LED-Leuchten und des täglichen / wöchentlichen Programmes

Radiador de 250 vatios equipado con control remoto estándar para regular las luces LED y el termostato de programación diario / semanal

Радиатор 250 Вт со стандартным пультом дистанционного управления для регулировки светодиодов и термостата: ежедневного / недельного программирования

codice code code Artikel Nr. codigo код	altezza height hauteur Höhe altura высота	larghezza width largeur Breite ancho ширина	output versione elettrica output for electrical version puissance en version electrique Output für elektrische Ausführung output versione agua elétrica выход электрического варианта watt*	peso weight poids Gewicht peso вес
	H mm	L mm		Kg
FSTIS1755LE...	1755	380	300	22

Alimentazione monofase 230 volt
Materiale: Alluminio e base acciaio inox

Single-phase power supply 230 Volt
Material: aluminium and stainless steel base

Alimentation monophasée 230 Volt
Matériel: aluminium et base en acier inoxydable

Einphasige Stromversorgung 230 Volt
Material: Aluminium und Sockel Edelstahl

Alimentación monofásica 230 Volitos
Material: Aluminio y base de acero inoxidable

Однофазный источник питания 230 вольт.
Материал – алюминий и основание из нержавеющей стали

Cavo con spina Schuko (mt 1,5)
Cable with Schuko plug (mt 1,5)
Câble avec prise Schuko (mt 1,5)
Kabel mit Schuko-Stecker (1,5m)
Cable con conector schuko (mt 1,5)
Кабель со штекером Schuko (1,5 м)

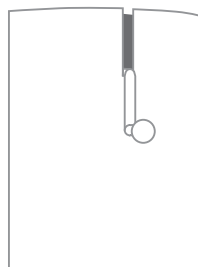

Appendiabito in acciaio inox satinato
Satin stainless steel clothes hook
Patère en acier inox satiné
Kleiderhalter aus satiniertem edelstahl
Pomo colgador de acero inoxidable satinado
Вешалка из сатиновой нержавеющей стали

CLASSE 1 - CLASS 1



FINITURE SPECIALI . SPECIAL FINISHES . FINITIONS SPECIALES - OBERFLÄCHENFARBEN - ACABADOS ESPECIALES . СПЕЦИАЛЬНАЯ ОТДЕЛКА



biotite



dark bronze



titanio



palladio



platino



ambra

caleido

STILUS DOUBLE ELEC LED

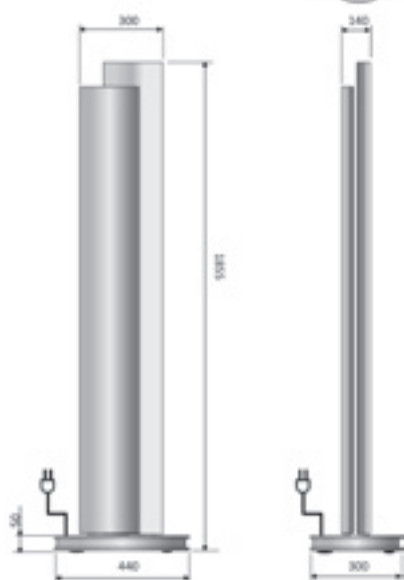
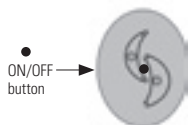

Calorifero con 500 watt di potenza, fornito con telecomando di serie per la regolazione delle luci LED e del termostato, programmazione giornaliera / settimanale

Radiator 500 watt power with standard remote control for regulation of the LED lights and thermostat, daily / weekly programming

Radiateur de 500 watt de puissance équipé d'une télécommande de série pour régler les lumières LED et le thermostat, programmation quotidienne / hebdomadaire

Heizkörper 500 Watt mit Fernbedienung zur Einstellung der LED-Leuchten und des täglichen / wöchentlichen Programmes

Radiator de 500 vatios equipado con control remoto estándar para regular las luces LED y el termostato de programación diario / semanal

Радикатор 500 Вт со стандартным пультом дистанционного управления для регулировки светодиодов и термостата ежедневного / недельного программирования



design by Giuseppe Bavuso

codice code code Artikel Nr. codigo код	altezza height hauteur Höhe altura высота	larghezza width largeur Breite ancho ширина	output versione elettrica output for electrical version puissance en version electrique Output für elektrische Ausführung output versione agua elettrica выход электрического варианта watt*	peso weight poids Gewicht peso вес
	H mm	L mm		Kg
FSTID1755LE...	1855	440	600	35

Alimentazione monofase 230 volt
Materiale: Alluminio e base acciaio inox

Single-phase power supply 230 Volt
Material: aluminium and stainless steel base

Alimentation monophasée 230 Volt
Matériel: aluminium et base en acier inoxydable

Einphasige Stromversorgung 230 Volt
Material: Aluminium und Sockel Edelstahl

Alimentación monofásica 230 Voltios
Material: Aluminio y base de acero inoxidable

Однофазный источник питания 230 вольт.
Материал – алюминий и основание из нержавеющей стали

Cavo con spina Schuko (mt 1,5)
Cable with Schuko plug (mt 1,5)
Câble avec prise Schuko (mt 1,5)
Kabel mit Schuko-Stecker (1,5m)
Cable con conector schuko (mt 1,5)
Кабель со штекером Schuko (1,5 м)

CLASSE 1 - CLASS 1

FINITURE SPECIALI . SPECIAL FINISHES . FINITIONS SPECIALES - OBERFLÄCHENFARBEN - ACABADOS ESPECIALES . СПЕЦИАЛЬНАЯ ОТДЕЛКА

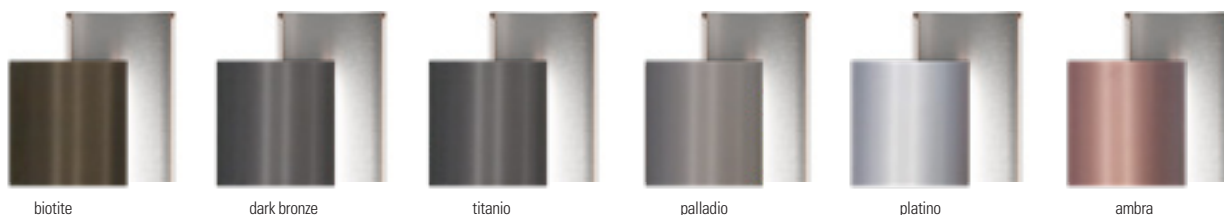

caleido

STILUS WALL ELEC

3D-BIM



design by Giuseppe Bavuso

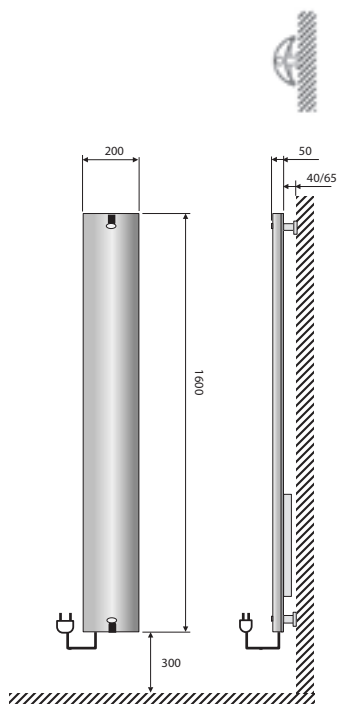

Calorifero con 250 watt di potenza, fornito con telecomando di serie per la regolazione delle luci LED e del termostato, programmazione giornaliera / settimanale

Radiator 250 watt power with standard remote control for regulation of the LED lights and thermostat, daily / weekly programming

Radiateur de 250 watt de puissance équipé d'une télécommande de série pour régler les lumières LED et le thermostat, programmation quotidienne / hebdomadaire

Heizkörper 250 Watt mit Fernbedienung zur Einstellung der LED-Leuchten und des täglichen / wöchentlichen Programmes

Radiator de 250 vatios equipado con control remoto estándar para regular las luces LED y el termostato de programación diario / semanal

Рadiator 250 Вт со стандартным пультом дистанционного управления для регулировки светодиодов и термостата: ежедневного / недельного программирования

Watt = Kcal/h × 0,860
Kcal/h = Watt × 0,860

codice code Artikel Nr. codigo код	altezza height hauteur Höhe altura высота	larghezza width largeur Breite ancho ширина	output versione elettrica output for electrical version puissance en version electrique Output für elektrische Ausführung output versione acqua elettrica выход электрического варианта
	H mm	L mm	Δt50
FSTIW1600E...	1600	200	300

Alimentazione monofase 230 volt
Materiale: Alluminio
Versione mista non disponibile

Single-phase power supply 230 Volt
Material: aluminium
Dual energy version is not available

Alimentation monophasée 230 Volt
Matériel: aluminium
La version mixte n'est pas disponible

Einphasige Stromversorgung 230 Volt
Material: Aluminium
Die gemischte Version ist nicht verfügbar

Alimentación monofásica 230 Volitos
Material: Aluminio.
La versión mixta no está disponible

Однофазный источник питания 230 вольт.
Материал – алюминий
Двойная версия не доступна

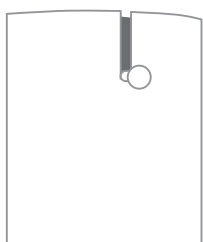

Appendiabito in acciaio inox satinato
Satin stainless steel clothes hook
Patère en acier inox satiné
Kleiderhalter aus satiniertem Edelstahl
Pomo colgador de acero inoxidable satinado
Вешалка из сатинированной нержавеющей стали



STILUS WALL ELEC LED

A richiesta: Kit LED con scheda e due barre Led 24 volt
On request: LED kit with circuit board and two LED lights 24 volt
Sur demande: Kit LED avec un circuit imprimé et deux lumières LED 24 volts
Auf Anfrage: Kit LED mit Leiterplatte und zwei LED-Leuchten 24 Volt
Bajo pedido: Kit LED con placa de circuito y dos luces LED de 24 voltios
По запросу: Комплект светодиодов с монтажной платой и двумя светодиодами 24 вольт



CLASSE 1 - CLASS 1

FINITURE SPECIALI . SPECIAL FINISHES . FINITIONS SPECIALES - OBERFLÄCHENFARBEN - ACABADOS ESPECIALES . СПЕЦИАЛЬНАЯ ОТДЕЛКА



biotite



dark bronze



titanio



palladio



platino



ambra

caleido